



Texas Instruments

PMP4488 Test Procedure

Asia Power Reference Design

REV A

10/19/2015

# **1 GENERAL**

## **1.1 PURPOSE**

To provide detailed data for evaluating and verifying the EVM.

## **1.2 REFERENCE DOCUMENTATION**

Schematic: PMP4488 SCH

PCB: PMP4488 PCB

BOM

## **1.3 TEST EQUIPMENTS**

Multi-meter(voltage): Fluke 287

Multi-meter(current): Fluke 287

DC Source: TDK-Lambda GEN100-33

Load: Chroma 63110A module

Oscilloscope: Tek DPO3054

# **2 INPUT CHARACTERISTICS**

## **2.1 Efficiency versus output current**

<b>Vin(V)</b>	<b>Iin(mA)</b>	<b>Vo(V)</b>	<b>Io(A)</b>	<b>Effi.(%)</b>
6.95	0.462	5.072	0.6	94.8
6.87	0.934	5.05	1.2	94.4
7.14	1.362	5.026	1.8	93.0
7.097	1.607	5.014	2.1	92.3
7.045	1.863	5	2.4	91.4
7.07	2.103	4.98	2.7	90.4
7.013	2.371	4.965	3	89.6

<b>Vin(V)</b>	<b>Iin(mA)</b>	<b>Vo(V)</b>	<b>Io(A)</b>	<b>Effi.(%)</b>
12	0.281	5.077	0.6	90.3
11.96	0.558	5.053	1.2	90.9
11.91	0.837	5.027	1.8	90.8
11.98	0.972	5.014	2.1	90.4
11.96	1.115	5	2.4	90.0
11.95	1.259	4.981	2.7	89.4
11.93	1.405	4.964	3	88.8

<b>Vin(V)</b>	<b>Iin(mA)</b>	<b>Vo(V)</b>	<b>Io(A)</b>	<b>Effi.(%)</b>
24.05	0.152	5.077	0.6	83.3
24	0.298	5.053	1.2	84.8
23.97	0.44	5.027	1.8	85.8
23.96	0.508	5.013	2.1	86.5

23.95	0.577	4.998	2.4	86.8
23.91	0.648	4.975	2.7	86.7
23.93	0.72	4.958	3	86.3

Vin(V)	Iin(mA)	Vo(V)	Io(A)	Effi.(%)
36.1	0.108	5.076	0.6	78.1
36.07	0.207	5.052	1.2	81.2
36.05	0.306	5.025	1.8	82.0
36.03	0.354	5.009	2.1	82.5
36.01	0.401	4.992	2.4	83.0
36	0.449	4.973	2.7	83.1
35.99	0.498	4.953	3	82.9

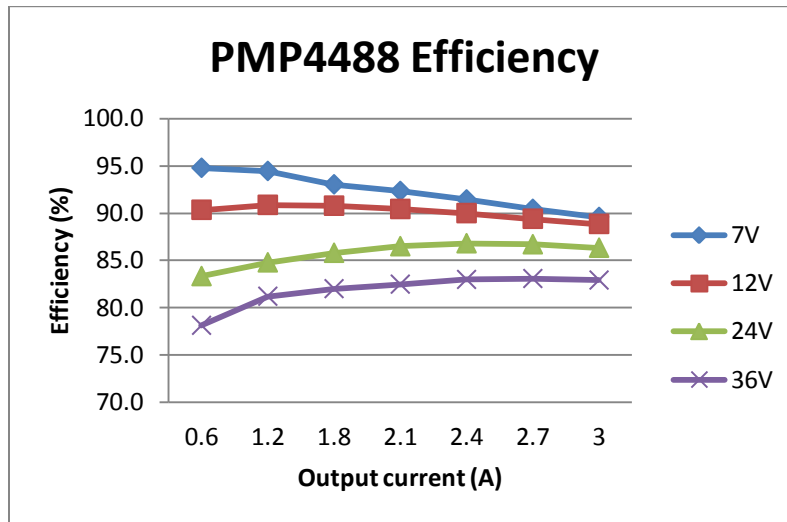

### 3 OUTPUT CHARACTERISTICS

#### 3.1 Load Regulation

Vin=12V

Io (A)	0	0.6	1.2	1.8	2.1	2.4	2.7	3
Vo (V)	5.103	5.077	5.053	5.027	5.014	5	4.981	4.964

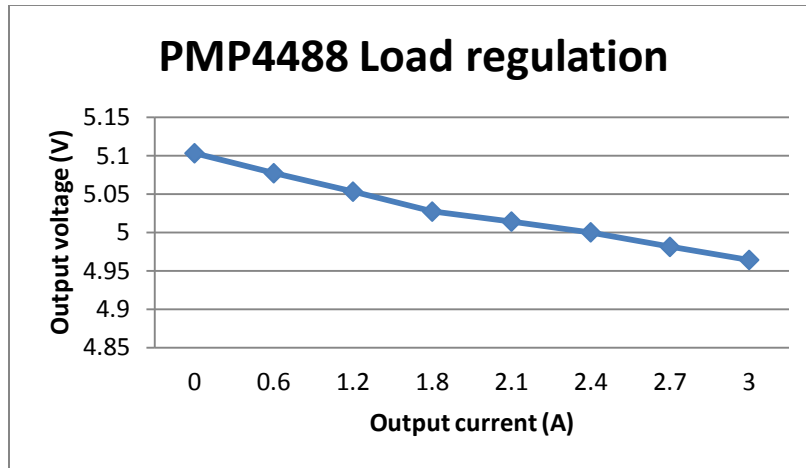

### 3.2 Line Regulation

Vin (V)	Vo (V)	
	Io=0A	Io=3A
7	5.103	4.965
12	5.103	4.964
24	5.104	4.958
36	5.105	4.953

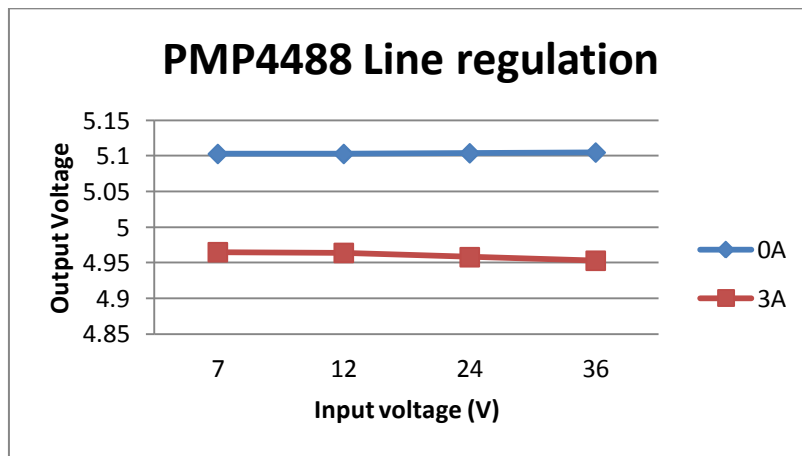

### 3.3 Ripple and noise

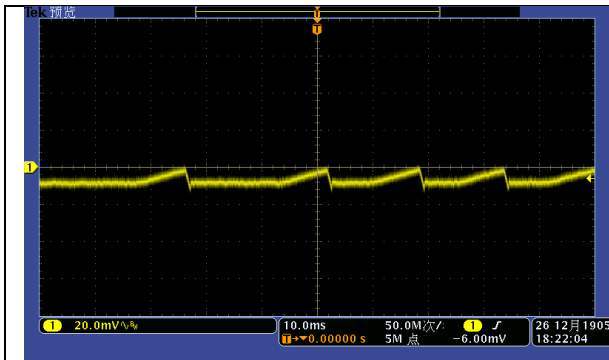

Vin=7V Io=0A  
Ch1: Vout Ripple

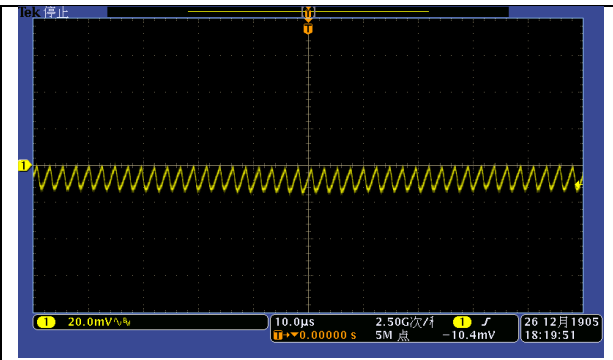

Vin=7V Io=3A  
Ch1: Vout Ripple

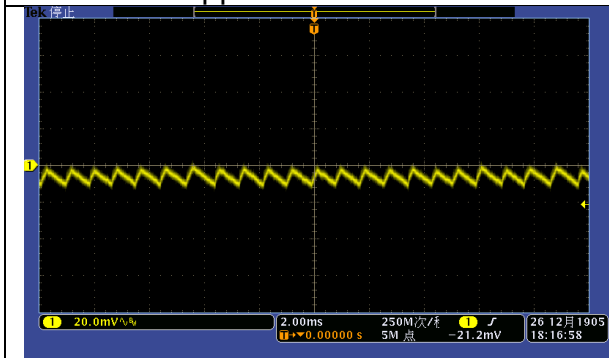

Vin=12V Io=0A  
Ch1: Vout Ripple

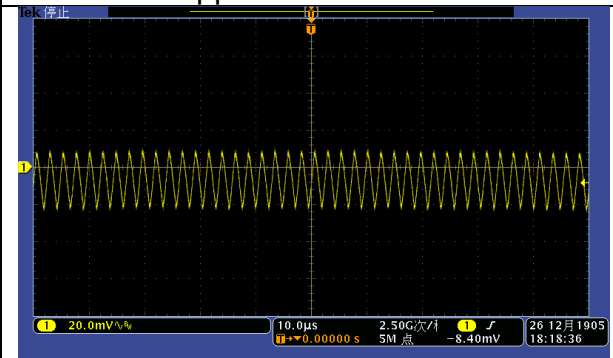

Vin=12V Io=3A  
Ch1: Vout Ripple

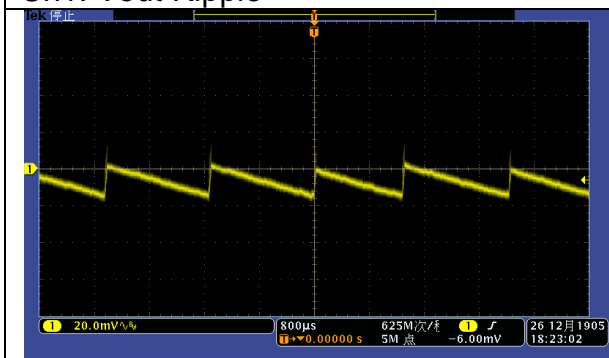

Vin=36V Io=0A  
Ch1: Vout Ripple

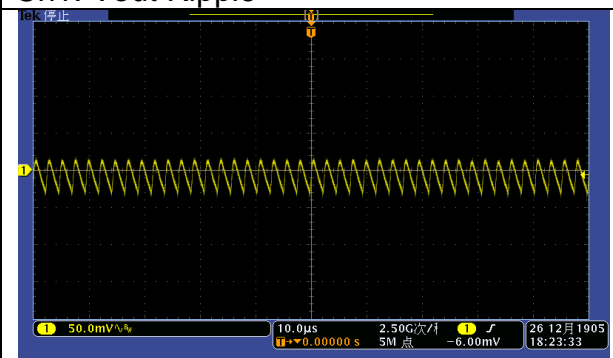

Vin=36V Io=3A  
Ch1: Vout Ripple

### 3.4 Start up

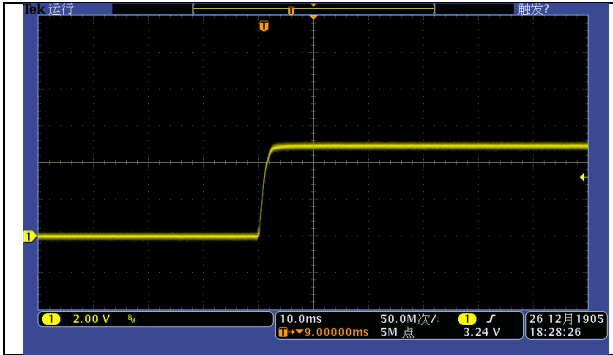

Vin=12V Io=3A  
Ch1: Vout

### 3.5 Shut down

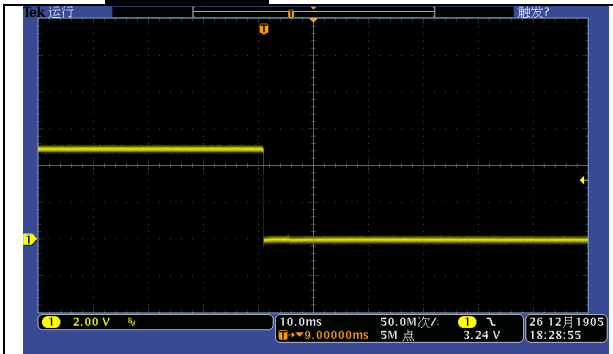

Vin=12V Io=3A  
Ch1: Vout

### 3.6 Load Transient

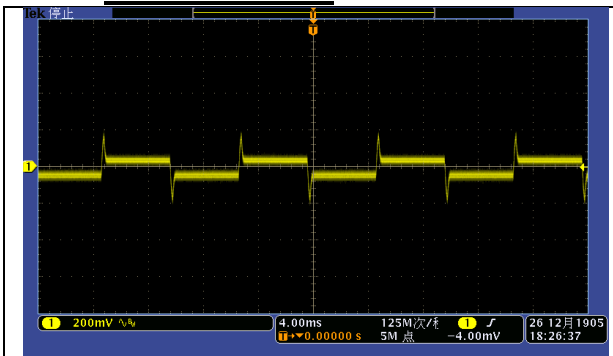

Vin=12V  
Io = 1A to 3A  
Ch1: Vout

## 4 Thermal

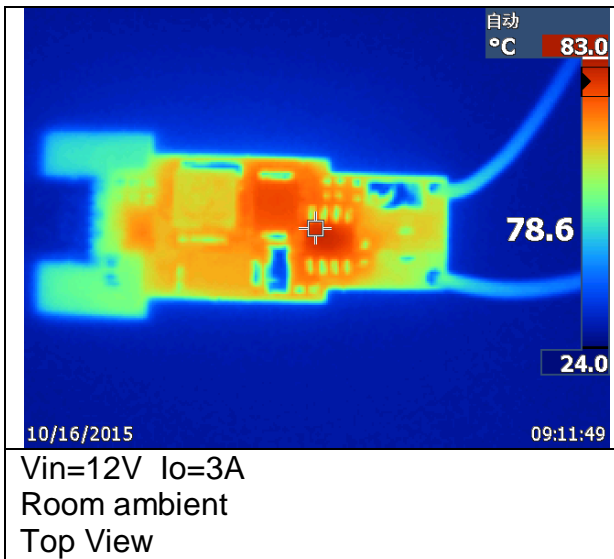

## IMPORTANT NOTICE AND DISCLAIMER

TI PROVIDES TECHNICAL AND RELIABILITY DATA (INCLUDING DATASHEETS), DESIGN RESOURCES (INCLUDING REFERENCE DESIGNS), APPLICATION OR OTHER DESIGN ADVICE, WEB TOOLS, SAFETY INFORMATION, AND OTHER RESOURCES "AS IS" AND WITH ALL FAULTS, AND DISCLAIMS ALL WARRANTIES, EXPRESS AND IMPLIED, INCLUDING WITHOUT LIMITATION ANY IMPLIED WARRANTIES OF MERCHANTABILITY, FITNESS FOR A PARTICULAR PURPOSE OR NON-INFRINGEMENT OF THIRD PARTY INTELLECTUAL PROPERTY RIGHTS.

These resources are intended for skilled developers designing with TI products. You are solely responsible for (1) selecting the appropriate TI products for your application, (2) designing, validating and testing your application, and (3) ensuring your application meets applicable standards, and any other safety, security, or other requirements. These resources are subject to change without notice. TI grants you permission to use these resources only for development of an application that uses the TI products described in the resource. Other reproduction and display of these resources is prohibited. No license is granted to any other TI intellectual property right or to any third party intellectual property right. TI disclaims responsibility for, and you will fully indemnify TI and its representatives against, any claims, damages, costs, losses, and liabilities arising out of your use of these resources.

TI's products are provided subject to TI's Terms of Sale (<https://www.ti.com/legal/termsofsale.html>) or other applicable terms available either on [ti.com](https://www.ti.com) or provided in conjunction with such TI products. TI's provision of these resources does not expand or otherwise alter TI's applicable warranties or warranty disclaimers for TI products.

Mailing Address: Texas Instruments, Post Office Box 655303, Dallas, Texas 75265  
Copyright © 2021, Texas Instruments Incorporated