

## TI Designs: TIDA-01359

# Analog Audio Amplifier Front End Reference Design with Improved Noise and Distortion



## Description

The Analog Audio Amplifier Front End Reference Design with Improved Noise and Distortion shows how to build an audio front end for a TPA32xx class-D amplifier.

This reference design uses a standard audio interface board (AIB) connector to drive two differential audio inputs of a TPA32xx EVM. The audio front end has selectable gains of 0, 6, and 12 dB and converts two single-ended audio signals into two fully-differential signals driving the inputs of the TPA32xx.

The distortion and noise performance (THD+N ratio) of the audio front end is significantly better than the THD+N ratio of the TPA32xx, which ensures that the audio front end does not degrade the performance of the overall system.

## Resources

[TIDA-01359](#)

Design Folder

[OPA1632](#)

Product Folder



[ASK Our E2E Experts](#)

## Features

- Single-Ended-to-Differential Conversion With Single Fully-Differential Amplifier Optimizes THD+N Ratio
- Four Parallel Connectors for Analog Inputs: XLR, ¼"-Stereo Phone, RCA, and SMA Jacks
- Gain is adjustable to 0 dB, 6 dB, and 12 dB
- Front End Accepts Differential Inputs in Addition to Single-Ended Inputs
- 100-kHz Bandwidth Matching Bandwidth of TPA32xx
- Low-Distortion Capacitors Used for DC-Blocking Inputs and for Filtering Outputs
- Single-Ended Input Impedance is 10 kΩ With 0-dB Gain and Increases to 12.5 kΩ With 12-dB Gain
- Selectable 12-V Supply From TPA32xx EVM or External Supply for Evaluation Without TPA32xx EVM

## Applications

- Blu-ray Disc™ and DVD Receivers
- High-End TV Sets
- High-End Soundbar
- Mini Combo Systems
- Active Speakers and Subwoofers

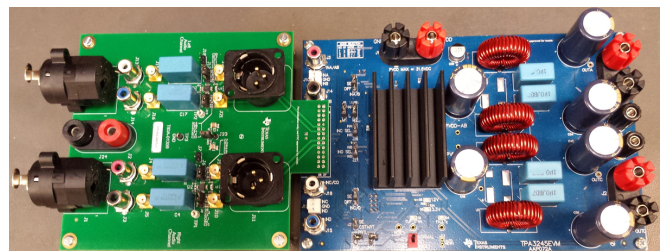
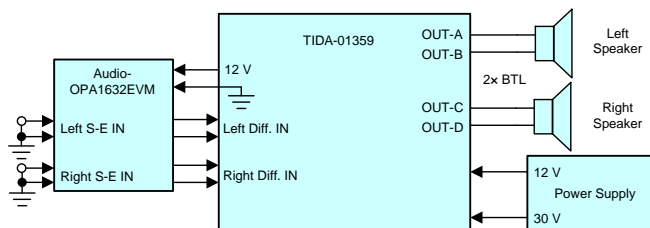

An IMPORTANT NOTICE at the end of this TI reference design addresses authorized use, intellectual property matters and other important disclaimers and information.

## 1 System Description

This reference design is an audio front end for a TPA32xx class-D amplifier. The OPA1632 is suited for high-end audio applications where minimizing noise and distortion is the primary concern.

This reference design was built and tested, and [Section 4](#) shows the test results. The test board is referred to as the "Audio-TIDA01359EVM" board. The design files (GERBER, BOM, schematic and layout layers) are included in the reference design documentation found in the [TIDA-01359](#) product folder.

Traditionally, professional and high-end consumer audio equipment such as active speakers, high-end TV, and high-end soundbar systems are the primary applications.

Broader audio categories such as mini-combo systems, Blu-ray disc, and DVD receivers are concerned with high-quality audio and utilize high-performance devices such as the OPA1632 in the audio signal chain.

[Table 1](#) shows the key specifications.

### 1.1 Key System Specifications

**Table 1. Key System Specifications**

PARAMETER	SPECIFICATIONS
Supply voltage	12-V TPA32xx AIB supply or external supply
THD+N	0.0003% with G = 0 dB, 1-kHz differential output, 2.54-V <sub>RMS</sub> (100-W TPA3245 output into 4-Ω BTL)
Single-ended input impedance	≥ 10 kΩ
Bandwidth	2 Hz to 100 kHz

## 2 System Overview

### 2.1 Block Diagram

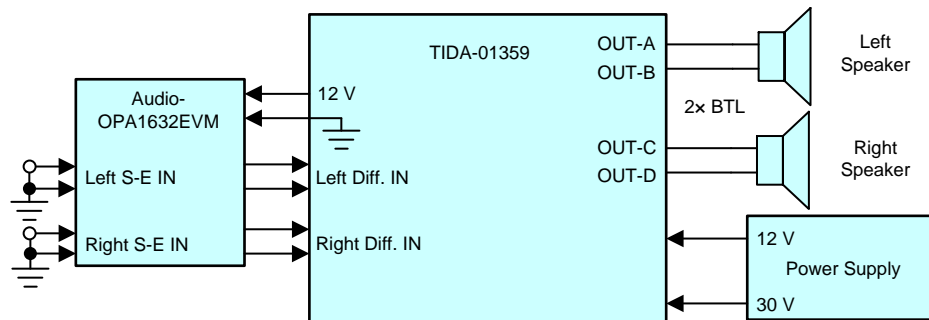

Figure 1. TIDA-01359 Block Diagram

### 2.2 System Design Theory

All performance plots in this section are measured data produced from the "Audio-TIDA01359EVM" board. The design files (GERBER, BOM, schematic and layout layers) are included in the reference design documentation found in the [TIDA-01359](#) product folder.

The most significant trade-off in this reference design is the input impedance versus the resistor thermal noise. Increasing resistors R11 and R12 in [Figure 5](#) increases the single-ended and differential input impedances but increases the noise at the amplifier output. To achieve the selectable gains of 0 dB, 6 dB, and 12 dB, the resistors R15 through R18 must increase proportionately, which further adds to the noise.

The minimum single-ended input impedance is 10 kΩ. For a single-ended input, the input impedance is higher than the R11 resistor because the input common-mode voltage of the amplifier is not constant. The changing OUT+ voltage is attenuated and fed back to the negative input of the amplifier, which forces the positive amplifier input to partially track the input voltage applied to R11. [Equation 1](#) shows the single-ended input impedance as a function of R<sub>f</sub> and R<sub>g</sub>. R<sub>g</sub> has a value of 7.5 kΩ to produce a single-ended input impedance of 10 kΩ with an amplifier gain of 0 dB.

$$Z_{in} = \frac{2R_g \left( 1 + \frac{R_f}{R_g} \right)}{\left( 2 + \frac{R_f}{R_g} \right)} \quad (1)$$

When R<sub>g</sub> = R<sub>f</sub> = 7.5 kΩ, the gain of the amplifier equals 0 dB and the broadband output noise and the relative contributions to the noise power are listed in [Table 2](#).

Table 2. Broadband Output Noise (Gain = 0 dB)

NOISE SOURCE	SPOT NOISE (nV/√Hz)	V <sub>RMS</sub> WITH 100-Hz BW (μV)	RELATIVE POWER (%)
R <sub>g</sub> = 7.5 kΩ	15.71	4.97	47.6
R <sub>f</sub> = 7.5 kΩ	15.71	4.97	47.6
Amp current noise	4.24	1.34	3.5
Amp voltage noise	2.6	0.82	1.3
Total noise	22.77	7.2	100

With  $R_g = 7.5\text{ k}\Omega$  and  $R_f = 15\text{ k}\Omega$ , the amplifier gain = 6 dB and the noise contributions are provided in the following [Table 3](#).

**Table 3. Contributors to Broadband Output Noise (Gain = 6 dB)**

NOISE SOURCE	SPOT NOISE (nV/ $\sqrt{\text{Hz}}$ )	V <sub>RMS</sub> WITH 100-Hz BW ( $\mu\text{V}$ )	RELATIVE POWER (%)
$R_g = 7.5\text{ k}\Omega$	31.42	9.94	63
$R_f = 15\text{ k}\Omega$	22.22	7.03	31.5
Amp current noise	8.49	2.68	4.6
Amp voltage noise	3.9	1.23	1
Total noise	39.6	12.52	100

When  $R_g$  equals  $7.5\text{ k}\Omega$  and  $R_f$  equals  $30\text{ k}\Omega$ , the gain of the amplifier equals 12 dB. [Table 4](#) lists the noise contributions.

**Table 4. Contributors to Broadband Output Noise (Gain = 12 dB)**

NOISE SOURCE	SPOT NOISE (nV/ $\sqrt{\text{Hz}}$ )	V <sub>RMS</sub> WITH 100-Hz BW ( $\mu\text{V}$ )	RELATIVE POWER (%)
$R_g = 7.5\text{ k}\Omega$	62.85	19.87	75
$R_f = 30\text{ k}\Omega$	31.42	9.94	18.7
Amp current noise	16.97	5.37	5.5
Amp voltage noise	6.5	2.06	0.8
Total noise	72.58	22.95	100

See the *Noise analysis* section of the [Analysis of Fully-differential Amplifiers \[1\]](#) technical brief. This is sourced from the TI Analog Application Journal for the calculation of the noise components.

The broadband noise of the amplifier is approximately 5% of the total output noise power for all three gain configurations. Normally, the voltage noise of the amplifier is larger than the current noise, but the large resistor values increase the power of the current noise without changing the voltage noise. Hence, large gain-setting resistors have two adverse effects: The resistor noise dominates the amplifier noise above the corner frequency of the amplifier and the contribution of the current noise of the amplifier increases.

At low frequencies, the flicker noise of the amplifier dominates the noise contributions from the resistors. An HP3589A spectrum analyzer measured the spot noise for the three gain configurations and [Figure 2](#) shows the results.

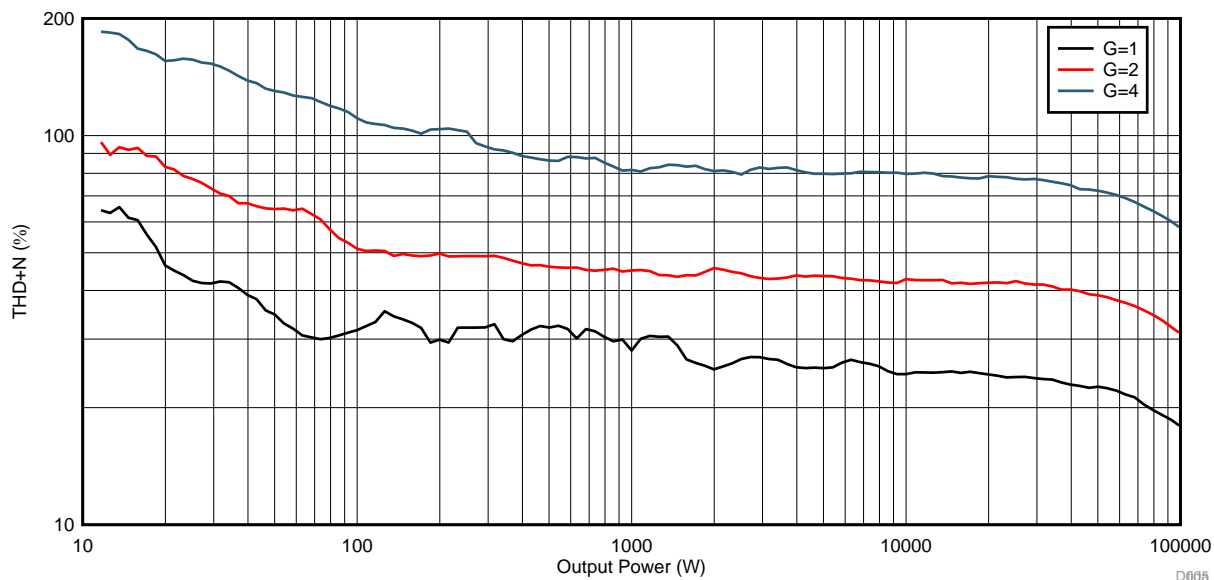

**Figure 2. OPA1632 Preampifier Spot Noise**

Note that the measured spot noise between 1 kHz and 20 kHz is close to the predicted values of 22.77 nV/√Hz, 39.6nV/√Hz, and 72.58 nV/√Hz for gains of 0 dB, 6 dB, and 12 dB, respectively. The corner frequency, where the flicker noise equals the broadband noise, is approximately 1 kHz. At 20 Hz, the spot noise is roughly twice the magnitude of the broadband noise. However, the sensitivity of the human ear to low sound levels diminishes significantly below 1 kHz, as the audio A-weighting curve in [Figure 3](#) shows.

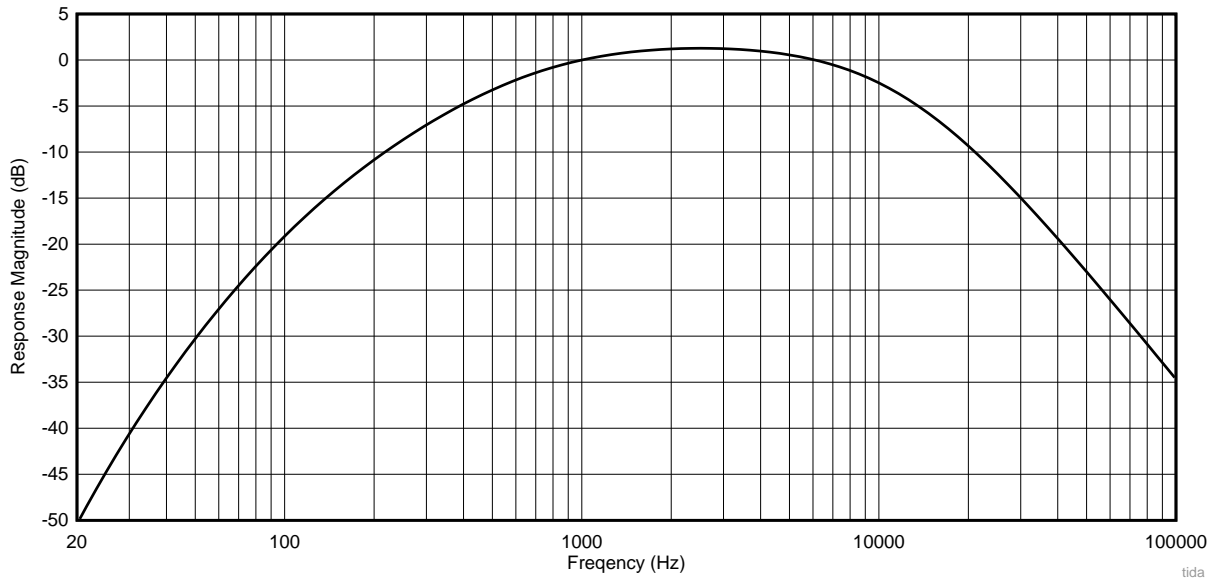

Figure 3. Audio A-Weighting

The measured A-weighted spot noise in [Figure 4](#) shows that the broadband noise from 1 kHz to 6 kHz (95% of which is from the gain-setting resistors) is the only significant perceived noise in the preamplifier. The voltage and current noise of the OPA1632 are imperceptible compared to the resistor noise of the pre-amp, despite the relatively large gain-setting resistors.

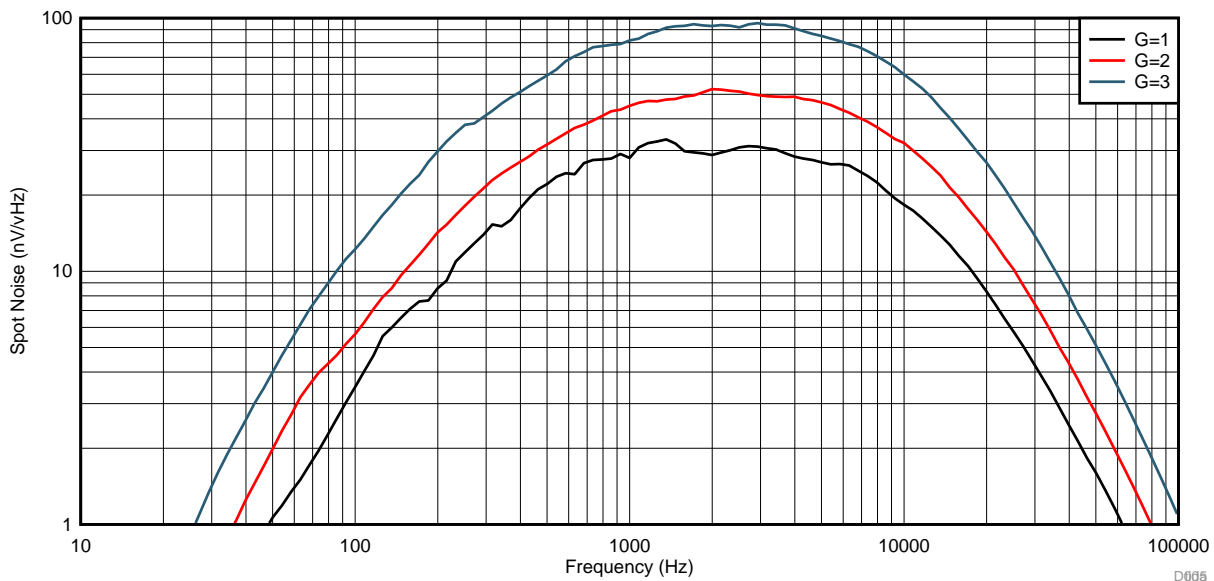

Figure 4. A-Weighted Spot Noise

If the broadband voltage noise and current noise of another amplifier are significantly higher than that of the OPA1632 device, which are  $1.3 \text{ nV}/\sqrt{\text{Hz}}$  and  $0.4 \text{ pA}/\sqrt{\text{Hz}}$ , respectively, then the noise of the amplifier is perceptible. The same applies if the corner frequency of the flicker noise is significantly higher than that of the OPA1632 device, which has a corner frequency of approximately 1 kHz. This analysis demonstrates that the very low noise of the OPA1632 makes the device designed for an FDA preamplifier with 10-k $\Omega$  input impedance.

The preceding noise analysis is the same for a single-ended or differential input signal. As a result, the OPA1632 reference design is an excellent preamplifier for differential inputs.

## 2.2.1 System Design Description

Figure 5 shows a simplified schematic of the Audio-OPA1632EVM. This diagram shows the circuit for the left audio channel.

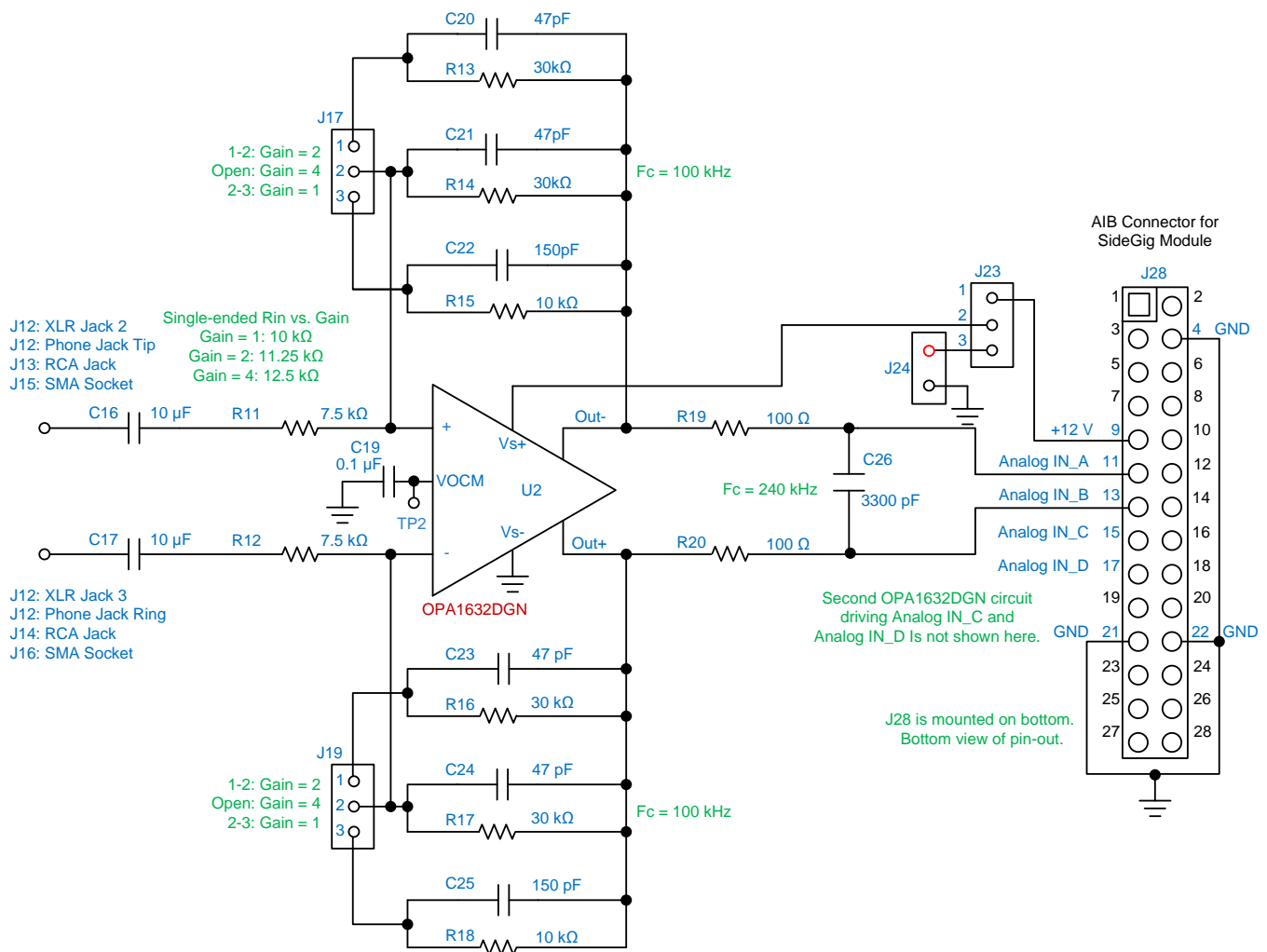

Copyright © 2017, Texas Instruments Incorporated

**Figure 5. Audio Reference Design Simplified Schematic**

Figure 6 shows a three-dimensional rendering of the Audio-OPA1632 EVM.

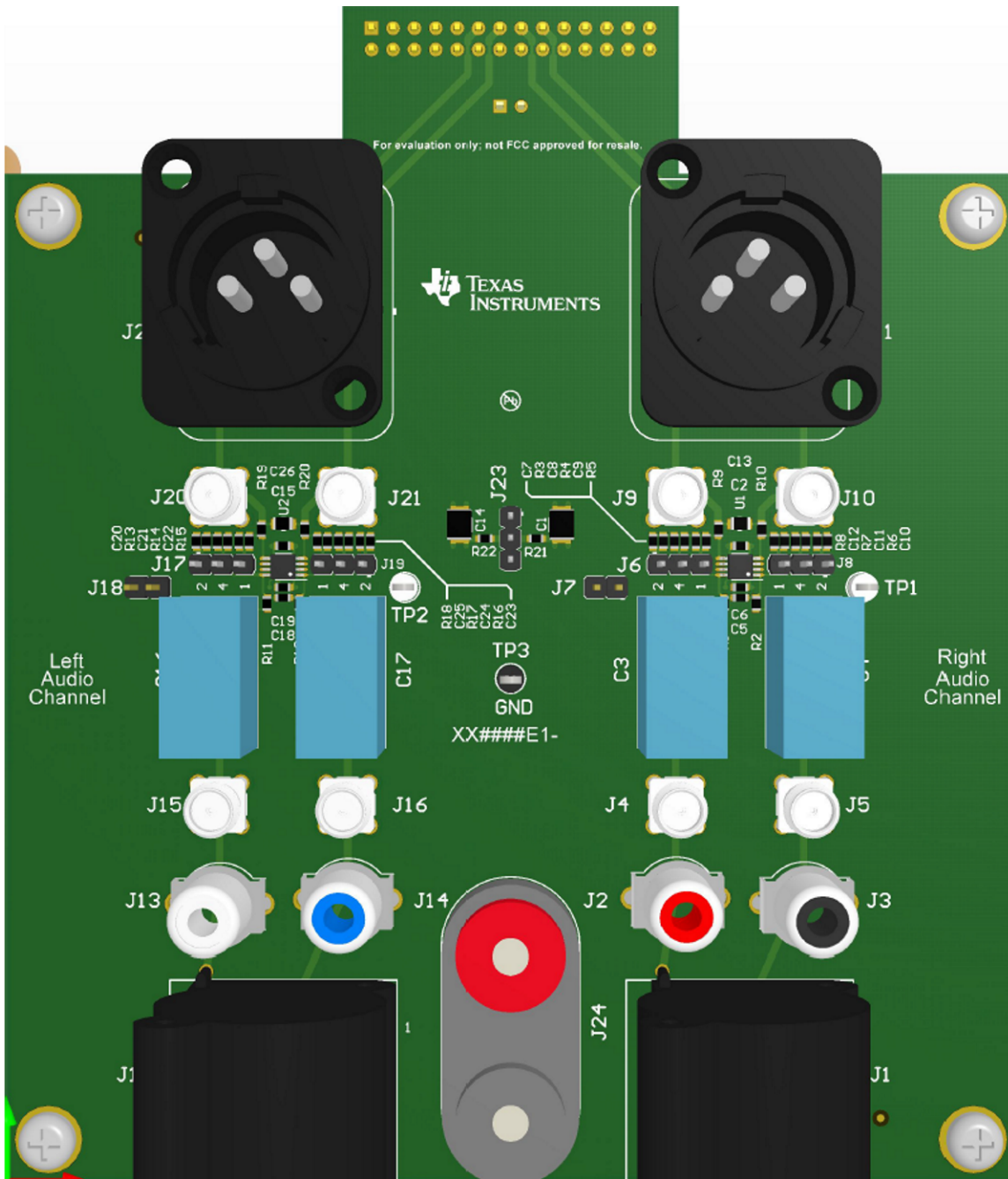

Figure 6. 3D Rendering of Audio-OPA1632EVM Top Side

Table 5 lists the pins used in the AIB connector, J28 on the Audio-OPA1632EVM.

**Table 5. AIB Connector Pin Descriptions**

PIN NUMBER	FUNCTION	DESCRIPTION	AUDIO EVM INPUT/OUTPUT	AUDIO INPUT/OUTPUT
5	GND	Ground reference between Audio and audio class-D EVM	—	—
9	12V	12-V source from EVM; used for powering Audio	O	I
11	Analog IN_A	Analog audio Input A (analog in EVM)	I	O
13	Analog IN_B	Analog audio Input B (analog in EVM)	I	O
15	Analog IN_C	Analog audio Input C (analog in EVM)	I	O
17	Analog IN_D	Analog audio Input D (analog in EVM)	I	O
21	GND	Ground reference between Audio and audio class-D EVM	—	—
22	GND	Ground reference between Audio and audio class-D EVM	—	—

Figure 7 shows the Neutrik NCJ6FI-H combo input jack (J12 in Figure 5 and Figure 6), which is a combination XLR and ¼” stereo phone jack.



**Figure 7. Neutrik NCJ6FI-H Combo Input Jack**

For a differential input signal, an XLR plug or a ¼” stereo phone (TRS) plug is preferred because these cables preserve the balance of the differential signal. For a single-ended input, these cables can be used, but one side of the signal must be grounded at the source. To ground the negative input for a single-ended input, the source connects the XLR pin 2 or the TRS ring to the source ground. Grounding the input at the source creates less imbalance and the naturally accompanying harmonic distortion than grounding at the Audio-OPA1632EVM input.

Single-ended inputs can be applied with RCA or SMA plugs with a separate cable that supplies the ground for the negative side of the OPA1632 device. In Figure 5, J14 or J16 jacks must be grounded at the source.

The Audio-OPA1632EVM has 10-μF polyester DC-blocking capacitors (C16 and C17 in Figure 5) on each input. Polyester capacitors are not a general recommendation because the capacitor dielectric must be tailored to the constraints of the application. In this application, polyester capacitors are a reasonable compromise between lower distortion, minimum size, and reasonable cost.

The high-pass cutoff frequency of the DC block is 2.1 Hz for differential inputs and a maximum of 1.6 Hz for a single-ended input. The input impedance for a single-ended input varies with the gain selected for the OPA1632 device due to the changing common-mode voltage at the OPA1632 input. Equation 2 shows the equation for the active impedance experienced by a low impedance single-ended input.:



$$Z_{in} = \frac{2R_g \left( 1 + \frac{R_f}{R_g} \right)}{\left( 2 + \frac{R_f}{R_g} \right)} \quad (2)$$

where:

- $R_g = 7.5 \text{ k}\Omega$
- $R_f = 7.5 \text{ k}\Omega$ ,  $15 \text{ k}\Omega$ , and  $30 \text{ k}\Omega$  for gains of 0 dB, 6 dB, and 12 dB, respectively.

Substituting the  $R_g$  and  $R_f$  values into [Equation 2](#) results in single-ended input impedances of  $10 \text{ k}\Omega$ ,  $11.25 \text{ k}\Omega$ , and  $12.5 \text{ k}\Omega$  for gains of 0 dB, 6 dB, and 12 dB, respectively, as [Figure 5](#) shows. The selectable gains in V/V are 1, 2, and 4, respectively.

Each  $R_f$  resistor has a parallel capacitor to create a low-pass filter cutoff frequency of 100 kHz. Any parallel combination of the  $R_f$  resistors preserves the 100-kHz cutoff frequency because the parallel resistance reduces by the same factor as the parallel capacitance increases. R14 and R17 in [Figure 5](#) are always in the feedback. The jumper selection in [Table 6](#) must be made on both sides of each OPA1632 amplifier to balance the feedback resistances on each amplifier and to select the same gain on both left and right audio channels. Jumpers J17 and J19 control the gain of the left audio channel. Jumpers J6 and J8 control the gain of the right audio channel.

The silkscreen labels on these jumpers are 2, 4, and 1 corresponding to jumper pins numbers 1, 2, and 3, respectively. The silkscreen labels facilitate selecting the gain: For a gain of 2, short the pins labeled 2 and 4; for a gain of 1, short the pins labeled 1 and 4. For a gain of 4, do not short any pins.

An attenuation of  $-1.9 \text{ dB}$  is achieved by shorting all three pins on each jumper, but this is not a typical configuration of the amplifier.

**Table 6. Jumper Connections for Selectable Gains**

GAIN	CONNECTIONS ON JUMPERS J6, J8, J17, AND J19
12 dB (4 V/V)	Open
6 dB (2 V/V)	Short pins labeled 2 and 4 (pins 1 and 2 of jumpers)
0 dB (1 V/V)	Short pins labeled 1 and 4 (pins 3 and 2 of jumpers)
$-1.6 \text{ dB}$ (0.8 V/V)	Short pins labeled 1, 2, and 4 (pins 1, 2, and 3 of jumpers)

The output common-mode voltage is set by the OPA1632 V<sub>OCM</sub> input. When a voltage is not forced on this input, the OPA1632 sets this voltage to midsupply, that is 6 V, when the TPA32xxEVM 12-V supply is selected. Test point TP2 shown in [Figure 5](#) is provided in case the user forces a voltage other than midsupply on the V<sub>OCM</sub> input. Capacitor C19 in [Figure 5](#) reduces the noise on this input, which reduces the output common-mode noise. Jumper J23 selects the 12-V supply for the Audio-OPA1632EVM per the connections in [Table 7](#). Short the middle pin on jumper 23 to the pin that is closest to the desired 12-V supply.

**Table 7. Jumper Connections for Selectable 12-V Power Supply**

12-V SUPPLY	CONNECTIONS ON JUMPER J23
TPA32xx AIB connector	Short pins 1 and 2
J24 (external supply)	Short pins 2 and 3

Resistors R19 and R20 and capacitor C26 in [Figure 5](#) create a first-order low-pass filter with a cutoff frequency of 240 kHz, which limits the noise bandwidth of the Side-Gig device. The class-D amplifier samples the differential input at the selectable modulation frequency of the pulse-width modulation (PWM) outputs. For the TPA3245EVM, the sample frequency,  $f_s$ , is 600 kHz. Due to this input sampling, high-frequency noise can alias back into the audio band; hence, the output filter acts as an antialiasing filter.

All feedback capacitors and capacitor C26 in [Figure 5](#) have COG dielectrics to minimize distortion. [Figure 8](#) is sourced from the [Where capacitance coefficients matter](#) forum posting[2] by TI applications engineer Bonnie Baker. This graph shows a comparison of the total harmonic distortion and noise (THD+N) for common capacitor dielectrics. Capacitors do not create noise; therefore, the differences in the THD+N measurements are due to differences in distortion created primarily by the voltage coefficient of capacitance of the various dielectrics.

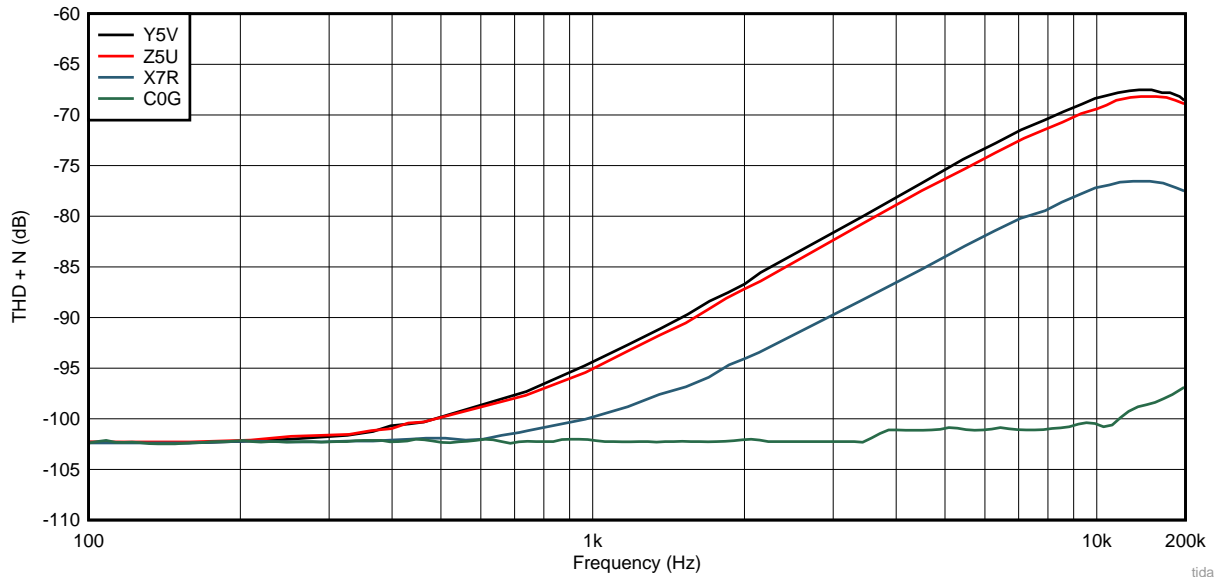

**Figure 8. Distortion for Common Capacitor Dielectrics**

For more information, see the [Signal distortion from high-K ceramic capacitors](#) how-to article[3] by TI applications engineer John Caldwell.

## 2.3 Design Considerations

### 2.3.1 Class-D EVM Compatibility

This reference design is compatible with analog input class-D EVMs designed with the audio interface board (AIB) connector. This compatibility includes TPA3244, TPA3245, and TPA3255 EVMs. See [Table 5](#) for details on the AIB connector.

### 2.3.2 Audio Output Type

This reference design drives two differential voltage outputs each capable of  $5.8 V_{RMS}$ .

### 2.3.3 Class-D EVM Input Type

This reference design is only compatible with analog input class-D EVMs with the AIB connector.

### 2.3.4 Supported Class-D Speaker Configurations

This reference design has two audio channels (labeled left and right) which are designed to drive the two differential-input channels of the TPA32xx amplifier configured for a 2x bridge-tied load (BTL), as Figure 9 shows.

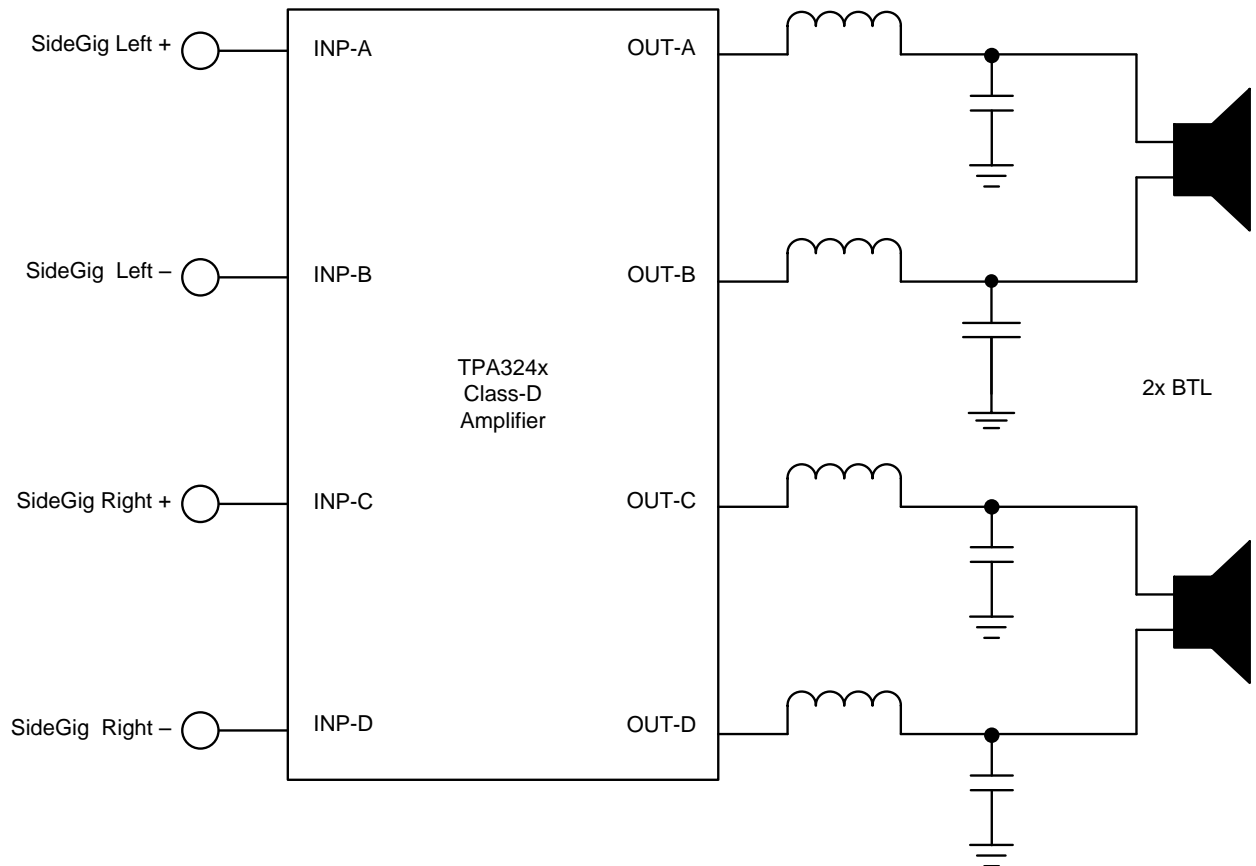

Copyright © 2017, Texas Instruments Incorporated

Figure 9. Input and Output Connections of TPA32xx EVM

## 2.4 Highlighted Products

### 2.4.1 OPA1632

The OPA1632 device offers the following features:

- Ultra-Low Distortion: 0.000022%
- Low Noise: 1.3 nV/ $\sqrt{\text{Hz}}$
- Fully-Differential Architecture: Balanced Input and Output Converts Single-Ended Input to Balanced Differential Output
- Wide Supply Range:  $\pm 2.5$  V to  $\pm 16$  V
- Shuts Down to Conserve Power

Historically, converting a single-ended signal into a differential signal has been accomplished with two operational amplifiers (op amps). Both amplifiers add noise and any mismatch in the two amplifiers creates distortion.

A single fully-differential amplifier (FDA) creates a differential output with better matching and hence lower distortion. Given the same flicker and broadband noise in the FDA and op amps, a single FDA amplifier adds half of the noise power compared to two op amps. FDAs have a secondary common-mode feedback loop which helps to reduce common-mode disturbances.

The 180-MHz gain-bandwidth product of the OPA1632 may seem excessive for an audio application, but this high bandwidth greatly reduces the distortion in the audio band. See the TI E2E™ online community forum post titled [Has distortion got your amplifier down? Get more bandwidth!](#)[4] for why this high bandwidth is useful in an audio application.

### 2.4.2 TPA3245

The TPA32454 device offers the following features:

- Differential Analog Inputs
- 95-W Stereo into 4  $\Omega$  and < 0.01% THS+N to Clipping
- 65-dB Power-Supply Rejection Ratio (BTL, No Input Signal)
- < 50- $\mu$ V (A-Weighted) Output Noise and > 112-dB (A-Weighted) Signal-to-Noise Ratio (SNR)
- Signal Bandwidth up to 100 kHz for Content from a High-Definition Source
- 90% Efficient Class-D Operation (4  $\Omega$ )

## 3 Getting Started Hardware

### 3.1 Hardware

#### 3.1.1 TPA32xx EVM Setup

The TPA32xx EVMs have RCA jack inputs for single-ended and differential inputs. These RCA jacks typically drive NE5532 op amps that drive the inputs to the TPA32xx class-D amplifier. This signal path is the default path whereas, the inputs through the AIB connector, which are used by the Audio-OPA1632EVM, are an optional signal path.

To use the AIB as the signal path to the TPA32xx class-D amplifier, four 0- $\Omega$  resistors must be removed to disconnect the default signal path. For the TPA3245EVM (AAP072A), these four resistors are R4, R12, R44, and R46. R4 and R12 are under the heat sink on the top side, which requires removing the heat sink to remove these resistors. Do not remove the thermally-conductive grease from the heat sink and the TPA32xx class-D amplifier. Reinstall the heat sink before operating the TPA32xx device.

For other TPA32xx EVMs, consult the EVM guide for the resistors to remove or for the jumper settings to disconnect the default signal path and connect the AIB signal path.

To configure the TPA3245EVM (AAP072A) for double BTL outputs, select INC on jumper J26 and select IND on jumper J27. These selections are made by shorting the lower two pins in each three-pin jumper. The mode-setting jumpers J5 and J6 are set to M1 = M2 = 0 by shorting the lower two pins in each three-pin jumper. The parallel bridge-tied load (PBTL) jumpers J7 and J8 are open. For other EVMs, consult the EVM guide for the jumper settings for double BTL outputs.

The TPA3245EVM supply (PVDD) is driven by an HP6623A power supply set to 30 V. Two channels of the HP6623A are stacked to provide sufficient current.

#### 3.1.2 Audio Precision Measurement Setup

All of the graphs shown in [Section 4](#) were measured using an Audio Precision AP-2522 with an AES17 filter.

The Audio-OPA1632EVM is measured separately using an external 12-V power supply. The single-ended output of the AP-2522 device is connected to the differential input of the Audio-OPA1632EVM using an XLR cable to preserve the balance of the impedances driving the input. [Figure 10](#) shows the XLR cable connections to drive a single-ended signal into the Audio-OPA1632EVM. The differential output of the Audio-OPA1632EVM drove the differential input of the AP-2522 device through an XLR cable with the shield grounded.

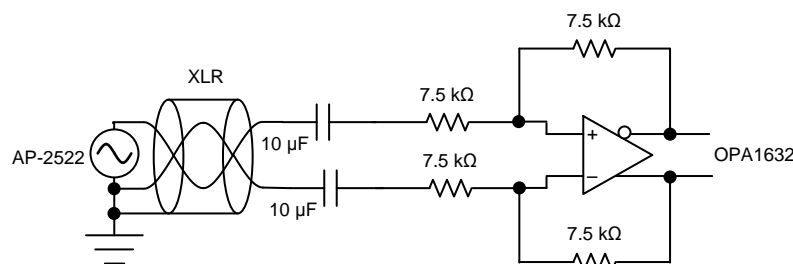

Copyright © 2017, Texas Instruments Incorporated

**Figure 10. AP-2522 Driving Single-Ended Signal Through XLR Cable**

Figure 11 shows the setup of the analog generator for the AP2700 software that controls the AP-2522 device.

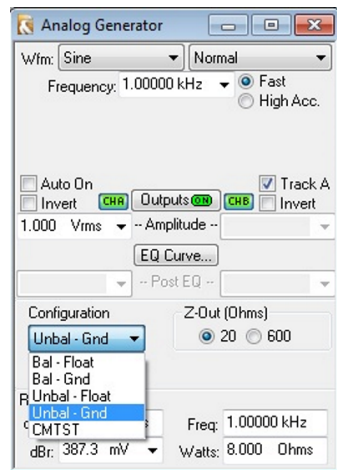

Figure 11. AP2700 Software Setup for Single-Ended Output

The AP2700 user's manual provides the diagram shown in Figure 12, which corresponds to the Unbal-Gnd output configuration.

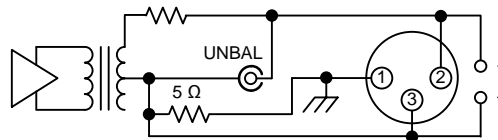

Figure 12. AP2700 Diagram of Unbal-Gnd Output Configuration

The TPA3245EVM performance is measured separately using the differential output of the AP-2522 device driving the differential input of the TPA3245EVM through an XLR cable with the shield grounded at the AP-2522. The AP2700 Bal-Gnd output configuration is selected, which connects the AP-2522 output as shown in Figure 13.

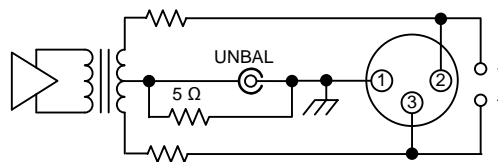

Figure 13. AP2700 Diagram of Bal-Gnd Output Configuration

The differential output of the TPA3245EVM drove the differential input of the AP-2522 through a twisted pair of wires with banana plugs to the AP-2522 device.

The combined performance of the Audio-OPA1632EVM and the TPA3245EVM is measured by driving the AP-2522 single-ended output signal into the Audio-OPA1632EVM as shown in Figure 10 and by driving the AP-2522 differential input with the TPA3245EVM differential output in a double BTL configuration.

### 3.1.3 TPA3245EVM Output Loads

For the measurements of the TPA3245EVM and the combined Audio-OPA1632EVM and TPA3245EVM, the differential outputs of the TPA3245EVM were loaded with 3 Ω, 4 Ω, or 8 Ω using Arcol HS200 4-Ω power resistors. The 8-Ω load consists of two Arcol resistors in series. The 3-Ω load consists of one Arcol 4-Ω resistor in parallel with three Arcol 4-Ω resistors in series:  $1 / 3 = 1 / (1 / 4 + 1 / 12)$ .

## 4 Testing and Results

All performance plots in this section are measured data produced from the "Audio-TIDA01359EVM" board. The design files (GERBER, BOM, schematic and layout layers) are included in the reference design documentation found in the product folder. [TIDA-01359](#)

The main objective of the performance measurements was to compare the noise and distortion of the Audio-OPA1632EVM to the TPA3245EVM. Based on the specifications of the OPA1632 and the TPA3245, the noise and distortion of the OPA1632 preamplifier converting a single-ended signal into a differential signal must be significantly lower than the noise and distortion of the TPA3245 device amplifying a differential input signal and driving a differential resistive load.

This expected performance difference is fundamentally due to the large currents driven by the TPA3245EVM compared to the small loads of the Audio-OPA1632EVM. The hypothesis is that the noise and distortion contributed by the Audio-OPA1632EVM preamplifier does not measurably degrade the performance of the TPA3245EVM. The combined performance of the Audio-OPA1632EVM and TPA3245EVM was measured and compared to the TPA3245EVM performance to test this hypothesis.

The harmonic distortion (HD) of a single tone and the intermodulation distortion (IMD) of two tones were measured. The IMD was measured using the SMPTE4:1 standard implemented by the AP-2522.

### 4.1 THD+N Comparisons

Figure 14 shows the THD+N comparisons of the AP2522, OPA1632EVM, TPA3245EVM, and the combined OPA1632EVM and TPA3245EVM. The signal frequency was 1 kHz with the signal power varied to produce an TPA3245EVM output signal into a 4-Ω resistor from 10 mW to 100 W. The OPA1632 was configured for a gain of 0 dB (1 V/V) and the TPA3245EVM supply voltage was set to 30 V. The sample frequency of the TPA3245 was 600 kHz.

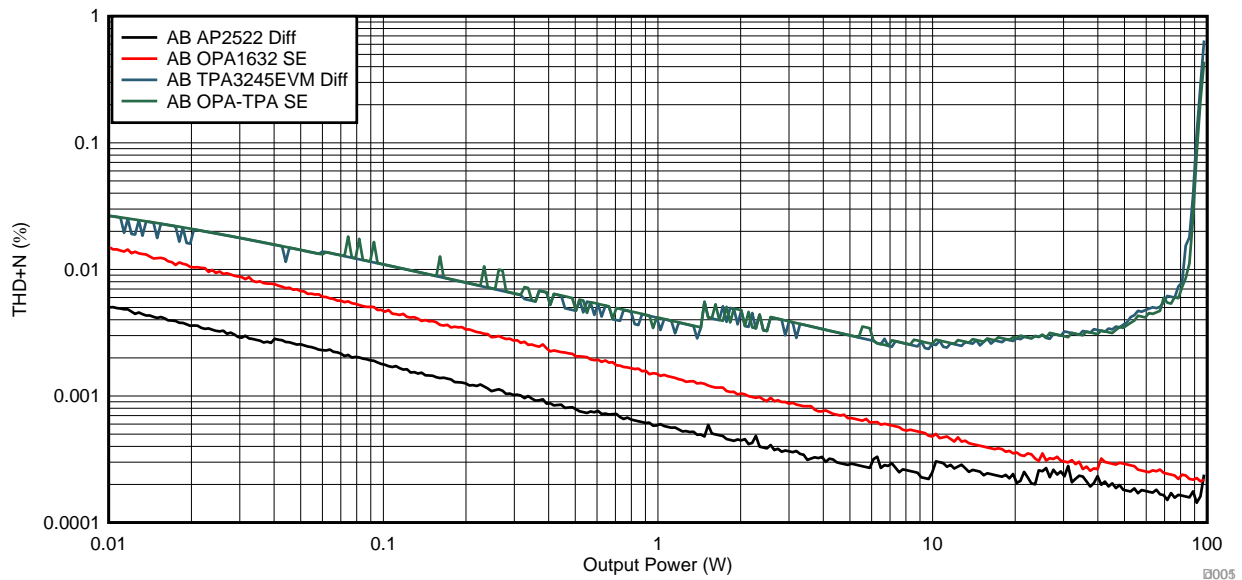

Figure 14. THD+N Comparisons of AP2522, OPA1632EVM, and TPA3245EVM With 4-Ω Load

The black line plotted in Figure 14 is the performance of the AP2522 driving a differential output through an XLR cable to its differential inputs. This graph establishes the performance of the measurement system; therefore, all subsequent measurements must have a higher THD+N as a percentage of the output signal.

The red line plotted in Figure 14 is the THD+N of a single-ended signal from the AP2522 converted to a differential signal by the OPA1632 device. Note that the THD+N of the OPA1632 at the lowest power level is about three times worse than the AP2522. However, the output configuration of the AP2522 was differential when measuring the AP2522 and single-ended when measuring the OPA1632. Some of the degradation in the OPA1632 measurement is likely due to the change in the AP2522 output configuration, but this degradation cannot be easily measured.

The near constant slope of the AP2522 and OPA1632 graphs below 1 W of the TPA3245EVM output implies that the performances of the AP2522 and OPA1632 are dominated by noise. The OPA1632 THD+N reduces by a factor of 10.4 from 10 mV to 1 W, which is a 100x increase in power. Because the THD+N has units of  $V_{RMS}$ , the square of THD+N has units of  $V_{RMS}^2$ , which is proportional to power. The reduction factor in  $THD+N^2$  is  $10.4^2 = 108.2$ , which is close to the 100x increase in signal power and also demonstrates that the OPA1632 performance is limited by a constant output noise and not by harmonic distortion.

Above the signal power to produce a 10-W TPA3245EVM output, the AP2522 graph starts to flatten, which indicates that distortion is becoming significant. Similarly, the OPA1632 graph starts to flatten above 40 W of system output.

The second-highest line plot (blue) in Figure 14 is the TPA3245EVM THD+N performance. Note that this data plot is 1.77 times higher than the OPA1632 plot at 10 mW and that the ratios grow as the power increases. The distortion of the TPA3245EVM starts to dominate the performance at about 7 W and starts to increase exponentially above 50 W. The spikes on the TPA3245EVM data below 3 W of output power are aliasing effects caused by the 600-kHz sample frequency.

The topmost line plot (teal) in Figure 14 is the combined THD+N of the OPA1632EVM driving the TPA3245EVM. This data plot essentially overlays the previous data plot and implies that the noise and distortion of the OPA1632EVM is insignificant compared to the TPA3245EVM. As mentioned previously, this result is not surprising given that the OPA1632EVM is driving a high impedance and the TPA3245EVM is driving 4  $\Omega$  after amplifying the signal by 18 dB (7.94 V/V).

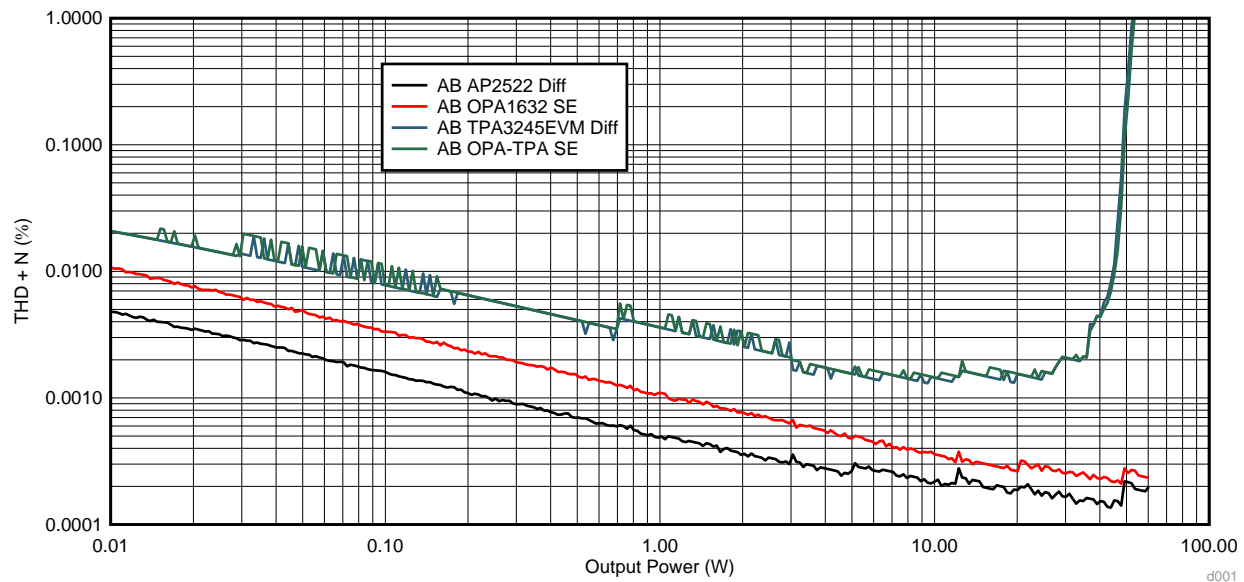
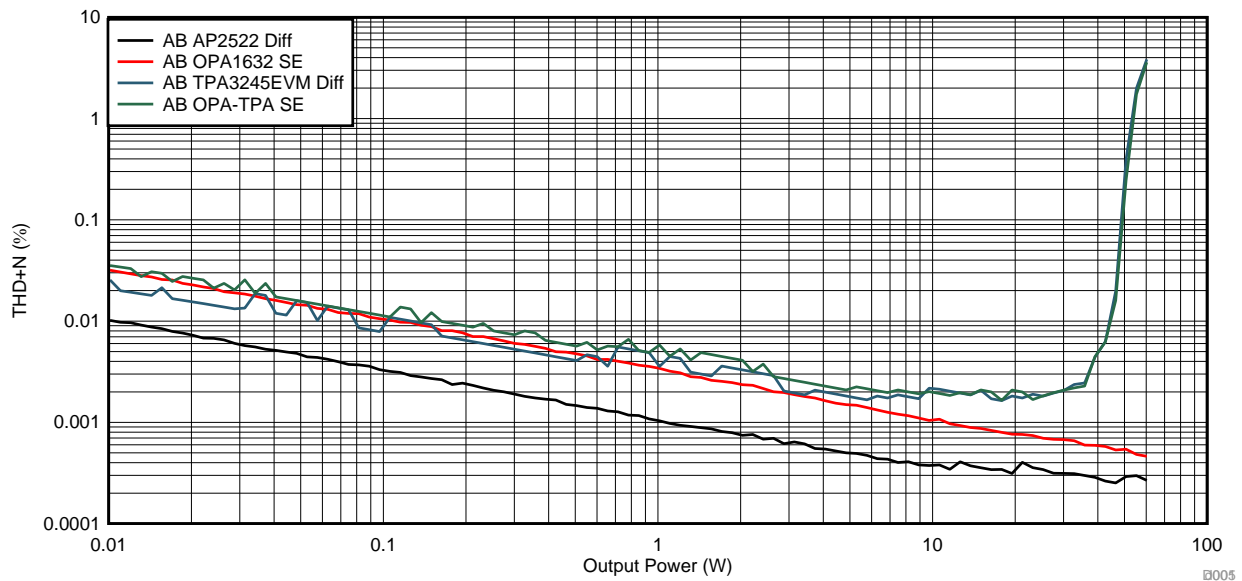

**Figure 15. THD+N Comparisons of AP2522, OPA1632EVM, and TPA3245EVM With 8- $\Omega$  Load**

The same observations on the THD+N with the 4- $\Omega$  load apply to the 8- $\Omega$  load except that the distortion becomes significant at lower power levels due to the higher output voltage for the same power level with the 4- $\Omega$  load.

Recall that the output noise of the OPA1632EVM with a gain of 12 dB is significantly higher than the noise with a gain of 0 dB. This result is primarily due to the gain applied to the noise from the  $R_g$  resistors. The higher noise with a gain of 12 dB is discernible below about 10 W of output power, as Figure 16 shows.

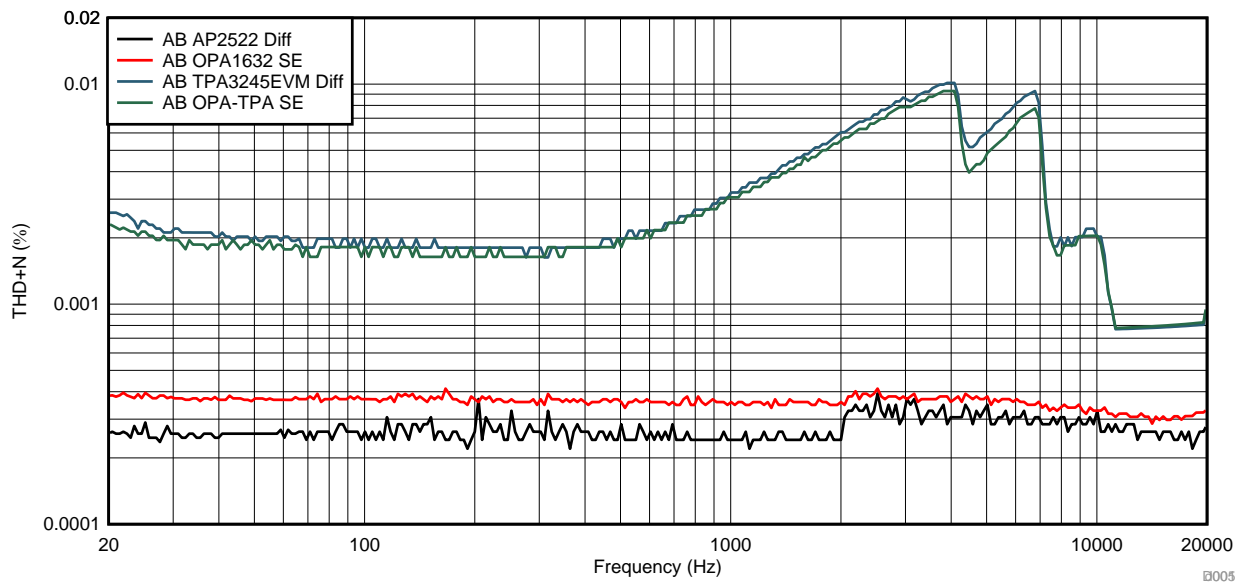



**Figure 16. THD+N versus Output Comparisons of AP2522, OPA1632EVM G = 12 dB, and TPA3245EVM**

Note that the output noise from the OPA1632EVM is higher than the noise from the TPA3245EVM below 600 mW and the noise of the combined signal path is higher than the TPA3245EVM noise below 8 W. This result is the only discernable degradation in performance observed in the combined signal path compared to the TPA3245EVM.

The distortion of the TPA3245EVM increases sharply with frequency at about 400 Hz, but the distortion of the OPA1632EVM is flat across the frequency band, which Figure 17 shows.



**Figure 17. THD+N vs Frequency Comparisons of AP2522, OPA1632EVM, and TPA3245EVM**

### 4.2 Intermodulation Distortion (IMD) Comparisons

The IMD performance of the various components versus amplitude is shown in Figure 18 while the performance over frequency appears in Figure 19. The OPA1632EVM IMD is indiscernible in the IMD of the combined OPA1632EVM and TPA3245EVM signal path.

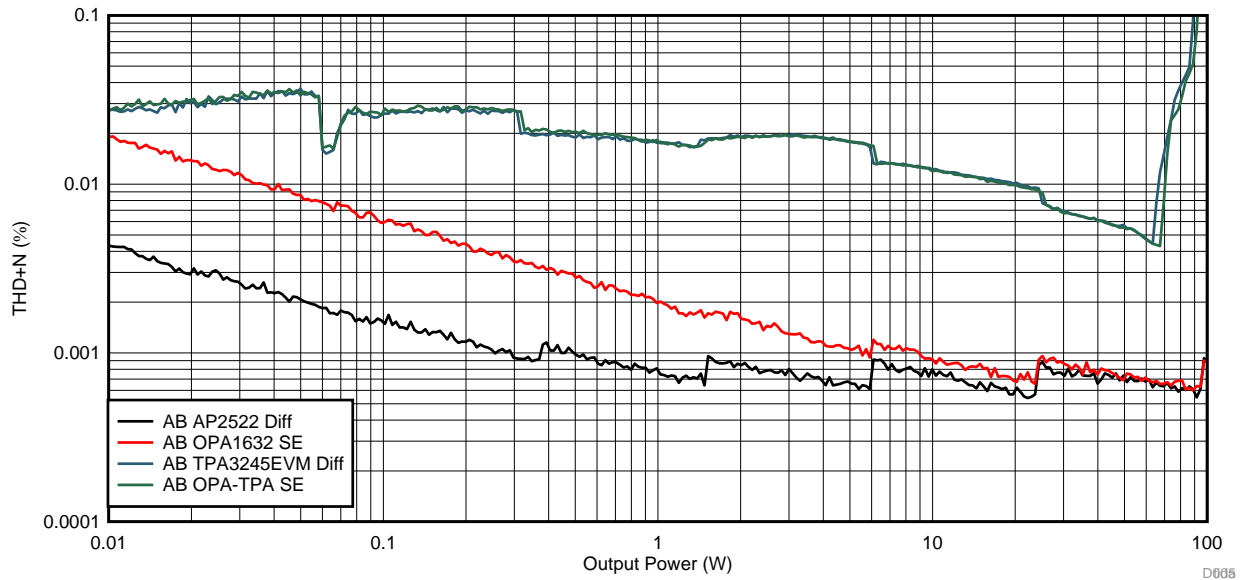

Figure 18. IMD vs Output Comparisons of AP2522, OPA1632EVM, and TPA3245EVM

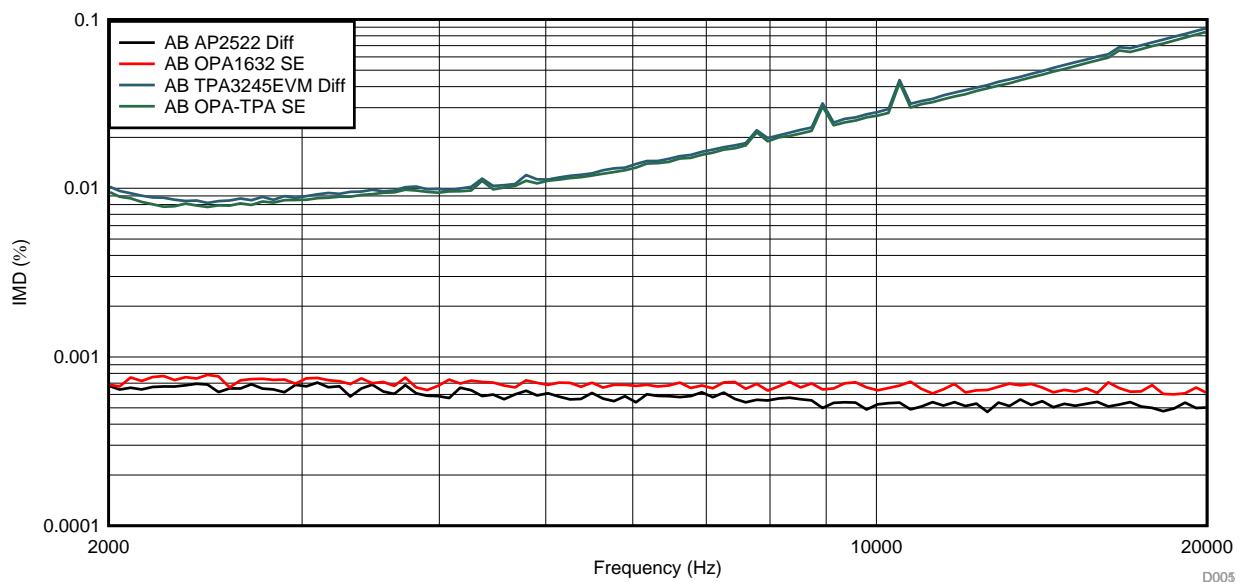

Figure 19. IMD vs Frequency Comparisons of AP2522, OPA1632EVM, and TPA3245EVM

The lowest frequency is 2 kHz because the SMPTE IMD test uses a fixed 60-Hz tone and a variable high-frequency tone starting at 2 kHz. Note that the OPA1632EVM performance is slightly worse than the AP2522 performance in this test.

### 4.3 Summary of Performance Comparisons

The harmonic distortion and intermodulation distortion of the OPA1632EVM converting a single-ended signal to a differential signal is far superior to the TPA3245EVM at all frequencies and power levels.

The output noise of the OPA1632EVM with a 0-dB gain configuration is superior to the TPA3245EVM output noise and is indiscernible in the overall system noise.

The output noise of the OPA1632EVM with a 12-dB gain configuration is discernable in the overall system noise at output levels below 8 W. The OPA1632EVM noise with 12-dB gain is primarily due to the noise from the  $R_g$  resistors. If lower input impedance of the OPA1632EVM is acceptable, this noise can be decreased by scaling down the  $R_g$  and  $R_f$  resistors that set the gain of the OPA1632EVM.

## 5 Design Files

### 5.1 Schematics

To download the schematics, see the design files at [TIDA-01359](#).

### 5.2 Bill of Materials

To download the bill of materials (BOM), see the design files at [TIDA-01359](#).

### 5.3 PCB Layout Recommendations

#### 5.3.1 Layout Prints

To download the layer plots, see the design files at [TIDA-01359](#).

### 5.4 Altium Project

To download the Altium project files, see the design files at [TIDA-01359](#).

### 5.5 Gerber Files

To download the Gerber files, see the design files at [TIDA-01359](#).

### 5.6 Assembly Drawings

To download the assembly drawings, see the design files at [TIDA-01359](#).

## 6 Software Files

To download the software files, see the design files at [TIDA-01359](#).

## 7 Related Documentation

1. Texas Instruments; Kariki, Jim; [Analysis of full differential amplifiers](#), Technical Brief (SLYT157)
2. Texas Instruments; Baker, Bonnie; [Where capacitance coefficients matter](#), TI E2E™ Online Community Forum Posting (Feb 2014)
3. EDN.com; Caldwell, John; [Signal distortion from high-K ceramic capacitors](#), EDN Network How-To Article (June 2013)
4. Texas Instruments; Comeaux, Wayne; [Has distortion got your amplifier down? Get more bandwidth!](#), TI E2E™ Online Community Forum Posting (Dec 2015)
- 5.

### 7.1 Trademarks

E2E is a trademark of Texas Instruments.

Blu-ray Disc is a trademark of Blu-ray Disc Association.

All other trademarks are the property of their respective owners.

## 8 About the Author

**WAYNE COMEAUX** is an applications engineer with TI in the high-speed amplifier division in Tucson, AZ. He validates the performance and specifications of high-speed amplifiers and provides customer support through TI online forums, application notes, and reference designs.

## IMPORTANT NOTICE FOR TI DESIGN INFORMATION AND RESOURCES

Texas Instruments Incorporated ("TI") technical, application or other design advice, services or information, including, but not limited to, reference designs and materials relating to evaluation modules, (collectively, "TI Resources") are intended to assist designers who are developing applications that incorporate TI products; by downloading, accessing or using any particular TI Resource in any way, you (individually or, if you are acting on behalf of a company, your company) agree to use it solely for this purpose and subject to the terms of this Notice.

TI's provision of TI Resources does not expand or otherwise alter TI's applicable published warranties or warranty disclaimers for TI products, and no additional obligations or liabilities arise from TI providing such TI Resources. TI reserves the right to make corrections, enhancements, improvements and other changes to its TI Resources.

You understand and agree that you remain responsible for using your independent analysis, evaluation and judgment in designing your applications and that you have full and exclusive responsibility to assure the safety of your applications and compliance of your applications (and of all TI products used in or for your applications) with all applicable regulations, laws and other applicable requirements. You represent that, with respect to your applications, you have all the necessary expertise to create and implement safeguards that (1) anticipate dangerous consequences of failures, (2) monitor failures and their consequences, and (3) lessen the likelihood of failures that might cause harm and take appropriate actions. You agree that prior to using or distributing any applications that include TI products, you will thoroughly test such applications and the functionality of such TI products as used in such applications. TI has not conducted any testing other than that specifically described in the published documentation for a particular TI Resource.

You are authorized to use, copy and modify any individual TI Resource only in connection with the development of applications that include the TI product(s) identified in such TI Resource. NO OTHER LICENSE, EXPRESS OR IMPLIED, BY ESTOPPEL OR OTHERWISE TO ANY OTHER TI INTELLECTUAL PROPERTY RIGHT, AND NO LICENSE TO ANY TECHNOLOGY OR INTELLECTUAL PROPERTY RIGHT OF TI OR ANY THIRD PARTY IS GRANTED HEREIN, including but not limited to any patent right, copyright, mask work right, or other intellectual property right relating to any combination, machine, or process in which TI products or services are used. Information regarding or referencing third-party products or services does not constitute a license to use such products or services, or a warranty or endorsement thereof. Use of TI Resources may require a license from a third party under the patents or other intellectual property of the third party, or a license from TI under the patents or other intellectual property of TI.

TI RESOURCES ARE PROVIDED "AS IS" AND WITH ALL FAULTS. TI DISCLAIMS ALL OTHER WARRANTIES OR REPRESENTATIONS, EXPRESS OR IMPLIED, REGARDING TI RESOURCES OR USE THEREOF, INCLUDING BUT NOT LIMITED TO ACCURACY OR COMPLETENESS, TITLE, ANY EPIDEMIC FAILURE WARRANTY AND ANY IMPLIED WARRANTIES OF MERCHANTABILITY, FITNESS FOR A PARTICULAR PURPOSE, AND NON-INFRINGEMENT OF ANY THIRD PARTY INTELLECTUAL PROPERTY RIGHTS.

TI SHALL NOT BE LIABLE FOR AND SHALL NOT DEFEND OR INDEMNIFY YOU AGAINST ANY CLAIM, INCLUDING BUT NOT LIMITED TO ANY INFRINGEMENT CLAIM THAT RELATES TO OR IS BASED ON ANY COMBINATION OF PRODUCTS EVEN IF DESCRIBED IN TI RESOURCES OR OTHERWISE. IN NO EVENT SHALL TI BE LIABLE FOR ANY ACTUAL, DIRECT, SPECIAL, COLLATERAL, INDIRECT, PUNITIVE, INCIDENTAL, CONSEQUENTIAL OR EXEMPLARY DAMAGES IN CONNECTION WITH OR ARISING OUT OF TI RESOURCES OR USE THEREOF, AND REGARDLESS OF WHETHER TI HAS BEEN ADVISED OF THE POSSIBILITY OF SUCH DAMAGES.

You agree to fully indemnify TI and its representatives against any damages, costs, losses, and/or liabilities arising out of your non-compliance with the terms and provisions of this Notice.

This Notice applies to TI Resources. Additional terms apply to the use and purchase of certain types of materials, TI products and services. These include; without limitation, TI's standard terms for semiconductor products (<http://www.ti.com/sc/docs/stdterms.htm>), [evaluation modules](#), and [samples](http://www.ti.com/sc/docs/sampterm.htm) (<http://www.ti.com/sc/docs/sampterm.htm>).

Mailing Address: Texas Instruments, Post Office Box 655303, Dallas, Texas 75265  
Copyright © 2018, Texas Instruments Incorporated