

TI Designs: TIDA-050010

Power Supply for NB-IoT Modems in Smart Meters With LiSOC12 Batteries Reference Design



Description

This reference design provides a power supply solution for NB-IoT (Narrow Band-Internet of Things) in smart meters with LiSOC12 Batteries applications. The design is a low standby current, high efficiency solution that extends battery use time more than 50%.

Resources

TIDA-050010	Design Folder
TPS61099	Product Folder
LMC555	Product Folder
CSD18533KCS	Product Folder



[ASK Our E2E™ Experts](#)

Features

- Operating Input Voltage From 2 V to 4 V
- Fixed Output Voltage of 3.6 V
- Output Current up to 320 mA
- Quiescent Current of 1 μ A Under Light Load Conditions
- About 4 μ A Standby Current at 85°C Under Open Load Conditions
- Up to 93% Efficiency from 10 mA to 320 mA
- Wide Input Voltage Range and High Efficiency Extends Battery Lifetime
- Simulates NB-IoT Load Characteristics for Easy Testing
- Small Solution Size With low External Component Count

Applications

- [Gas Meters](#)
- [Heat Meters](#)
- [Water Meters](#)

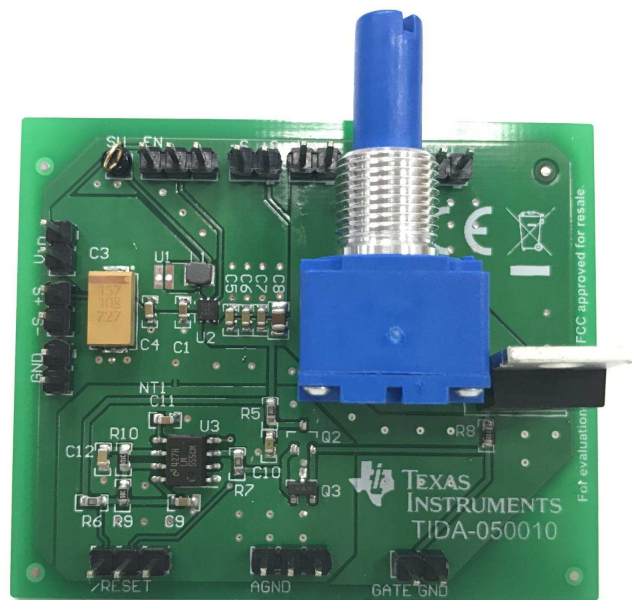
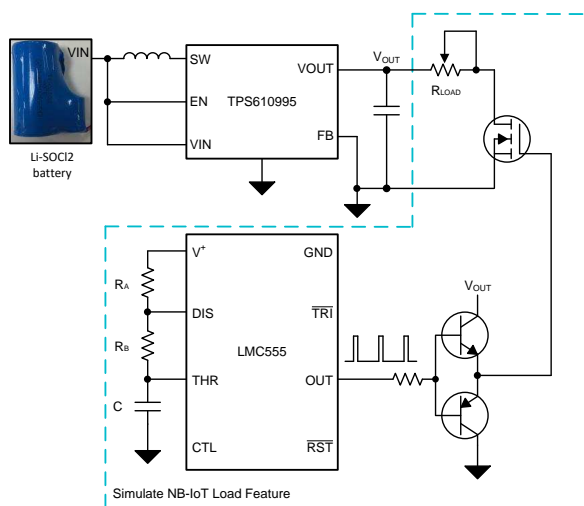

An IMPORTANT NOTICE at the end of this TI reference design addresses authorized use, intellectual property matters and other important disclaimers and information.

1 System Description

Smart meters consists of electricity meters, gas meters, heat meters and water meters. Some smart meters use NarrowBand-Internet of Things (NB-IoT) to transfer data and information. This technology supports battery life of more than 10 years for a wide range of use cases. The typical range of input voltage of NB-IoT modules (such as the ZTE ZM8300G module) is from 3 V to 4.2 V (with a typical voltage 3.6 V). The typical maximum peak current for these modules is up to 300 m A.

The Li-SOCI2 battery currently has the highest energy density, the longest storage period, and the least self-discharge rate (less than 1% per year at room temperature). This battery is very useful for smart meters including e-meters, water meters, and trackers, which are long-term products. The typical voltage of a Li-SOCI2 battery is approximately 3 to 3.6 V, and the maximum continuous output current is approximately 150 mA for an 8.5-Ah battery. Because the continuous output current of a Li-SOCI2 battery is not enough for NB-IoT, a super capacitor is connected with Li-SOCI2 battery in parallel to provide a pulse high current.

Figure 1 shows the voltage curves for a Li-SOCI2 battery (3.67 V) in parallel with super capacitor (SPC1520) with a discharge current is 350 mA. At low ambient temperature, the output voltage of the Li-SOCI2 battery is less than 3 V. The NB-IoT module connected directly to a Li-SOCI2 battery stops working even though a large capacity (about 2/3 capacity at -20°C) is still available, so a boost converter is needed. The TPS610995 can boost the battery voltage to 3.6 V to give a steady power to NB-IoT module.

Figure 1. Voltage Curves for Li-SOCI2 Battery (3.67 V) In Parallel With Super Capacitor, 350 mA

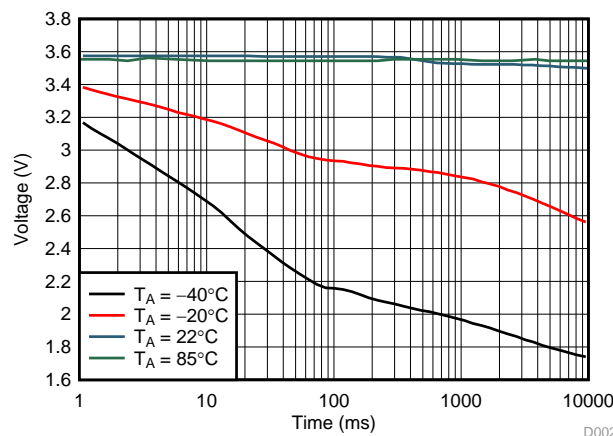

(1) See the [EVE SPC \(Super Pulse Capacitor cell\) Model SPC1520.data sheet](#). for more information.

1.1 Key System Specifications

Table 1. Key System Specifications

PARAMETER	SPECIFICATIONS
Input voltage range	2 V to 4 V
Output voltage	3.6 V
Output current	up to 320 mA
No load input current ($V_{in}= 3\text{ V}$)	1 μA
Efficiency ($V_{in}= 3\text{ V}$, $I_{out}= 300\text{ mA}$)	94 %
Monitor load range	2 Ω to 1 k Ω

2 System Overview

2.1 Block Diagram

Figure 2 shows the system block diagram. This system has two parts. One is the TPS610995 boost converter to boost the Li-SOCI2 battery to 3.6 V, the other part is simulate NB-IoT load feature.

Figure 2. TIDA-050010 Block Diagram

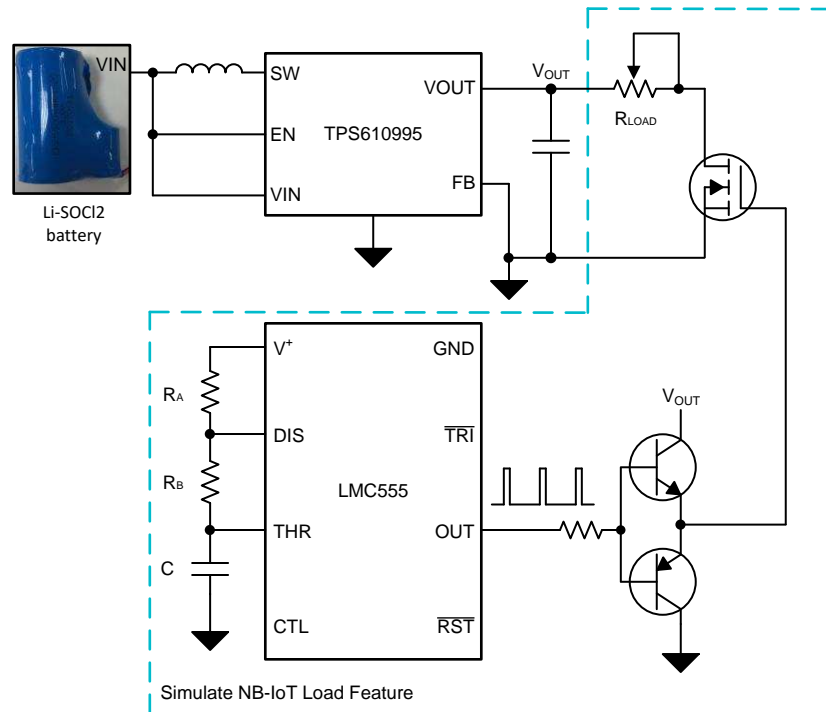

2.2 Design Considerations

2.2.1 Load Monitor

This reference design uses the LMC555 device to generate a pulse that drives a MOSFET to monitor the NB-IoT load feature. Users can change the resistance by sliding the rheostat (R_{LOAD}) to change the peak output current.

Use Equation 1 to calculate the pulse width of the output load current of the LMC555 device.

$$t_{on} = 0.693 \times (R_A + R_B) \times C = 0.693 \times (1 \text{ k}\Omega + 23.2 \text{ k}\Omega) \times 10 \text{ }\mu\text{F} = 167 \text{ ms} \quad (1)$$

Use Equation 2 to calculate the frequency of the output load current of the LMC555 device.

$$f = 1.44 \times (R_A + 2 \times R_B) \times C = 1.44 \times (1 \text{ k}\Omega + 2 \times 23.2 \text{ k}\Omega) \times 10 \text{ }\mu\text{F} = 3 \text{ Hz} \quad (2)$$

2.3 Highlighted Products

2.3.1 TPS610995

The TPS610995 is part of the TPS61099 family of devices. The TPS610995 device is a fixed output voltage ($V_{out} = 3.6\text{ V}$) version. The TPS610995 boost converter uses a hysteretic control topology to obtain maximum efficiency at minimal quiescent current. The TPS610995 device only consumes 1- μA quiescent current and can achieve up to 75% efficiency at a 10- μA load. The TPS610995 device can also support up to 320-mA output current from 2 V to 3.6 V conversion and achieve up to 93% at a 320-mA load. The TPS610995 device also offers Down Mode operation. In Down Mode, the output voltage can still be regulated at a target value even when the input voltage is higher than the output voltage. The TPS610995 device supports true shutdown function when it is disabled, which disconnects the load from the input supply to reduce the current consumption. The TPS610995 device is available in a 6-pin, 2-mm \times 2-mm, WSON package, the total boost converter size is about 14mm*8mm, including a input tantalum capacitor and a output 0603 ceramic capacitor.

2.3.2 LMC555

The LMC555 device is a CMOS version of the industry standard 555 series general-purpose timers. The LMC555 offers the same capability of generating accurate time delays and frequencies as the LM555 but with much lower power dissipation and supply current spikes. When operated as a one-shot, the time delay is precisely controlled by a single external resistor and capacitor. In the astable mode the oscillation frequency and duty cycle are accurately set by two external resistors and one capacitor. The use of TI's LMC MOS process extends both the frequency range and the low supply capability.

2.3.3 CSD18533KCS

The CSD18533KCS is a 5.0 m Ω , 60 V TO-220 NexFET™ power MOSFET, which is designed to minimize losses in power conversion applications.

3 Hardware, Testing Requirements, and Test Results

3.1 Required Hardware

3.1.1 Hardware

The reference design used this hardware to test the design:

- DC power source
- Digital oscilloscope
- Multimeters

3.2 Testing and Results

3.2.1 Test Setup

See [Section 4.1](#) and [Section 4.2](#) for the test schematic and bill of materials.

To test the design:

1. Check that pin 1 and pin 2 of U1 are connected by a line.
2. Connect the EN pin (pin 2) to the input voltage (pin 3) through the EN jumper.
3. Connect the $\overline{\text{RESET}}$ pin (pin 2) to the input voltage (pin 3) through the $\overline{\text{RESET}}$ jumper.
4. Connect the input terminal of the reference board to the DC power source.

3.2.2 Test Results

3.2.2.1 Comparison

Figure 3 and Figure 4 show a comparison of the test results. Channel 2 is the output of a Li-SOCI2 battery connected to the super capacitor. Channel 1 is the output of the TPS610995 boost converter. Channel 4 is the output current.

A 320-mA, 130-ms pulse current was used to monitor the NB-IoT load feature. Figure 3 shows the test result using a Li-SOCI2 battery connected directly to a super capacitor. At -40°C ambient temperature, the output of the Li-SOCI2 battery decreases to 2.8 V at a 320-mA pulse current. The NB-IoT module stops in this case. Figure 4 shows the test result using the TPS610995 boost converter. The output of the TPS610995 boost converter is stable at the pulse output current. The NB-IoT module continues steady operation.

Figure 3. Simulate NB-IoT Working Without TPS610995 at $T_A = -40^{\circ}\text{C}$

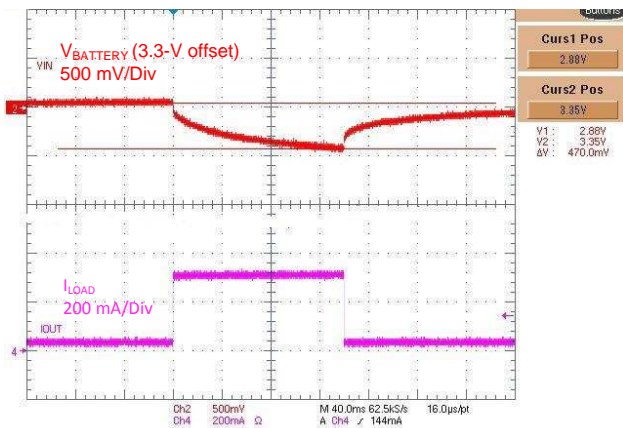
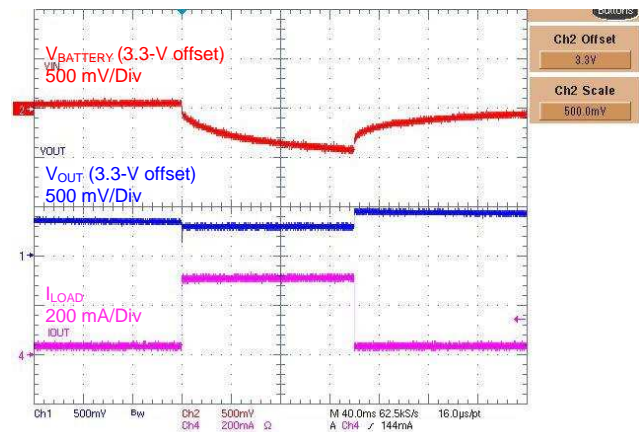

Figure 4. Simulate NB-IoT Working With TPS610995 at $T_A = -40^{\circ}\text{C}$



3.2.2.2 Efficiency Curves

Figure 5 shows the efficiency curves for each input voltage.

Figure 5. TPS610995 Load Efficiency for Different Input Voltages

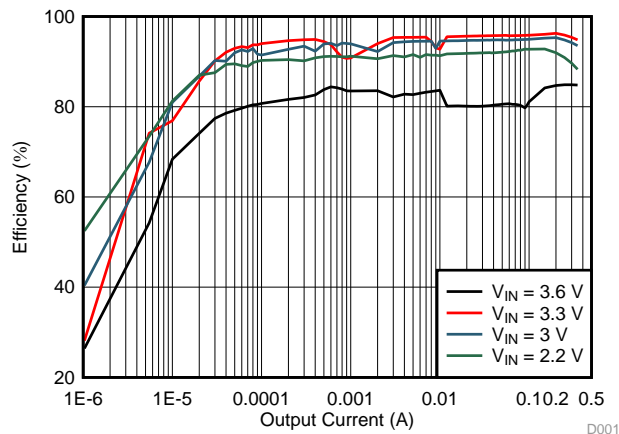

3.2.2.3 Output Voltage Ripple

Figure 6, Figure 7, and Figure 8 show the waveforms for output voltage ripple. Figure 6 shows burst mode operation, Figure 7 shows discontinuous current operation and Figure 8 shows continuous current operation.

Figure 6. Output Voltage Ripple

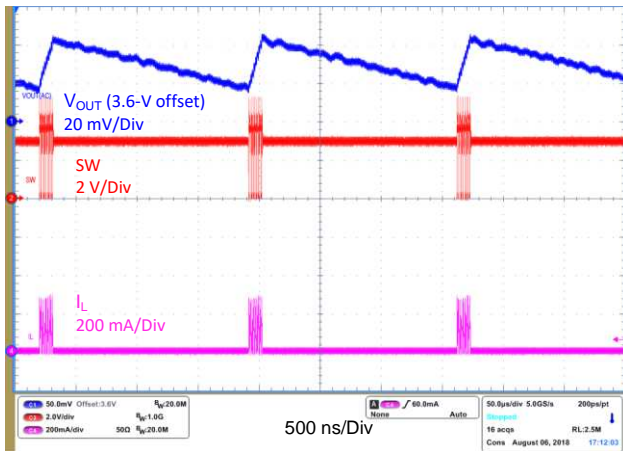

$V_{IN} = 3\text{ V}$; Open Load

Figure 7. Output Voltage Ripple

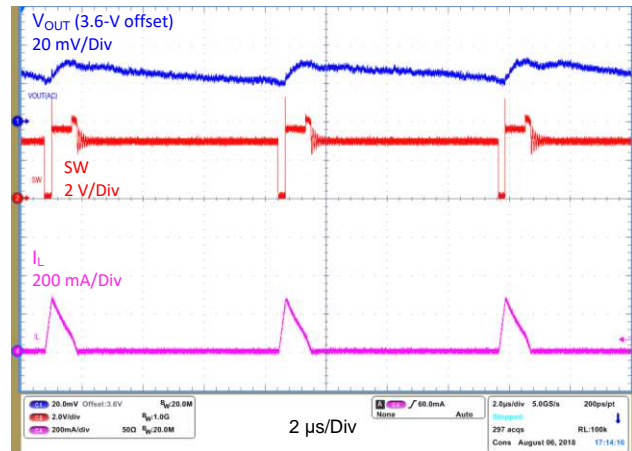

$V_{IN} = 3\text{ V}$; $I_{OUT} = 10\text{ mA}$

Figure 8. Output Voltage Ripple

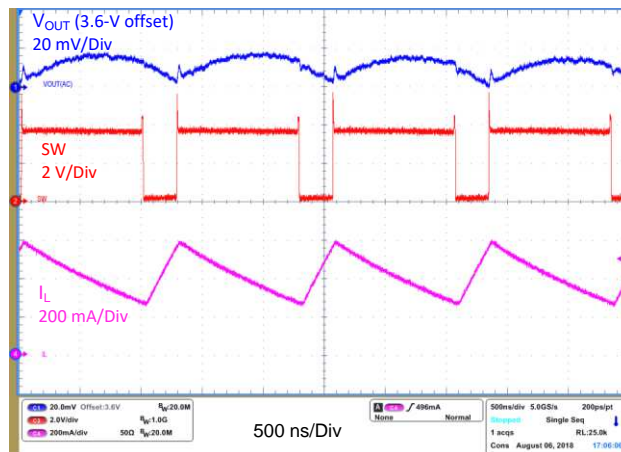

$V_{IN} = 3\text{ V}$; $I_{OUT} = 320\text{ mA}$

3.2.2.4 Start Up by EN

Figure 9 and Figure 10 show the waveforms for start up by EN.

Figure 9. Startup by EN

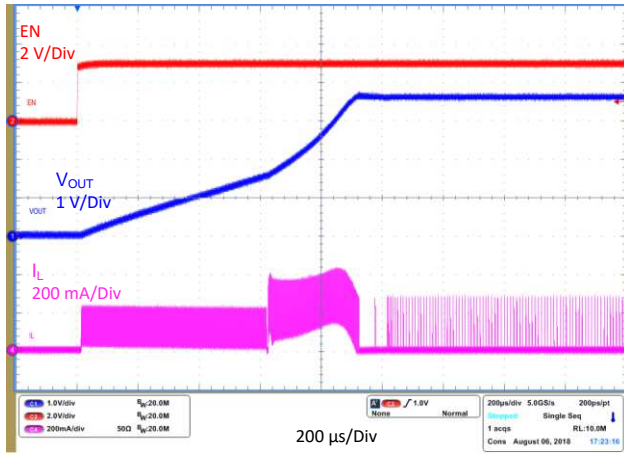

$V_{IN} = 3\text{ V}$; $I_{OUT} = 10\text{ mA}$

Figure 10. Startup by EN

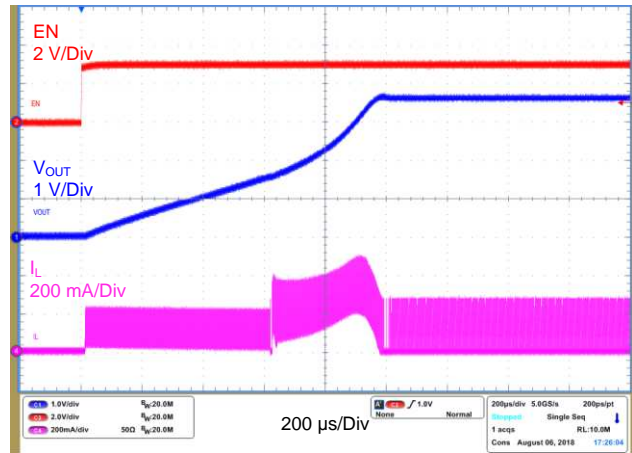

$V_{IN} = 3\text{ V}$; $I_{OUT} = 50\text{ mA}$

3.2.2.5 Load Transient

Figure 11 and Figure 12 show the load transient waveforms.

Figure 11. Load Transient

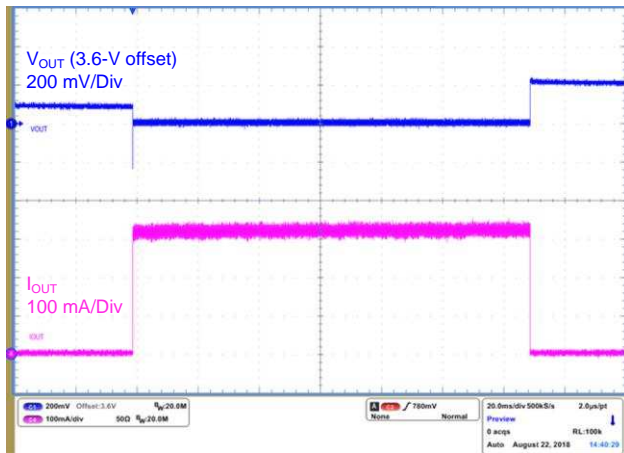

$V_{IN} = 3\text{ V}$; I_{OUT} from 0 mA to 320 mA

Figure 12. Load Transient

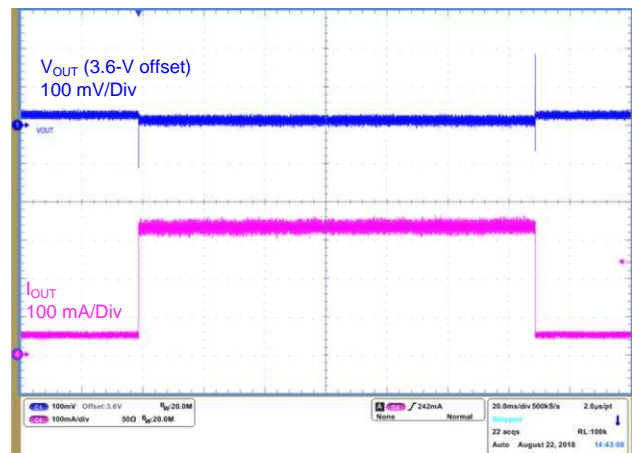

$V_{IN} = 3\text{ V}$; I_{OUT} from 50 mA to 320 mA

3.2.2.6 Line Regulation

Figure 13 shows the line regulation waveform.

Figure 13. Line Regulation

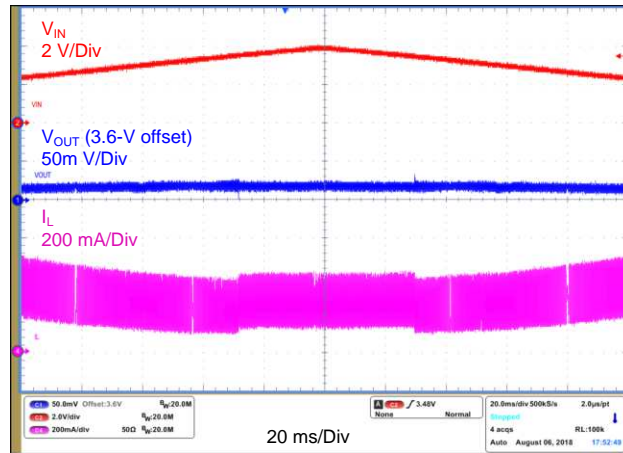

4 Design Files

4.1 Schematics

To download the schematics, see the design files at [TIDA-050010](#).

4.2 Bill of Materials

To download the bill of materials (BOM), see the design files at [TIDA-050010](#).

4.3 Layout Prints

To download the layer plots, see the design files at [TIDA-050010](#).

4.4 Altium Project

To download the Altium Designer® project files, see the design files at [TIDA-050010](#).

4.5 Gerber Files

To download the Gerber files, see the design files at [TIDA-050010](#).

4.6 Assembly Drawings

To download the assembly drawings, see the design files at [TIDA-050010](#).

5 Related Documentation

1. Texas Instruments, [CSD18533KCS 60 V N-Channel NexFET™ Power MOSFET data sheet](#)
2. Texas Instruments, [LMC555 CMOS Timer data sheet](#)
3. Texas Instruments, [TPS61099x Synchronous Boost Converter with Ultra-Low Quiescent Current data sheet](#)
4. Endrich, [EVE SPC \(Super Pulse Capacitor cell\) Model SPC1520.data sheet](#).

5.1 Trademarks

E2E, NexFET are trademarks of Texas Instruments.
Altium Designer is a registered trademark of Altium LLC or its affiliated companies.
All other trademarks are the property of their respective owners.

IMPORTANT NOTICE AND DISCLAIMER

TI PROVIDES TECHNICAL AND RELIABILITY DATA (INCLUDING DATASHEETS), DESIGN RESOURCES (INCLUDING REFERENCE DESIGNS), APPLICATION OR OTHER DESIGN ADVICE, WEB TOOLS, SAFETY INFORMATION, AND OTHER RESOURCES "AS IS" AND WITH ALL FAULTS, AND DISCLAIMS ALL WARRANTIES, EXPRESS AND IMPLIED, INCLUDING WITHOUT LIMITATION ANY IMPLIED WARRANTIES OF MERCHANTABILITY, FITNESS FOR A PARTICULAR PURPOSE OR NON-INFRINGEMENT OF THIRD PARTY INTELLECTUAL PROPERTY RIGHTS.

These resources are intended for skilled developers designing with TI products. You are solely responsible for (1) selecting the appropriate TI products for your application, (2) designing, validating and testing your application, and (3) ensuring your application meets applicable standards, and any other safety, security, or other requirements. These resources are subject to change without notice. TI grants you permission to use these resources only for development of an application that uses the TI products described in the resource. Other reproduction and display of these resources is prohibited. No license is granted to any other TI intellectual property right or to any third party intellectual property right. TI disclaims responsibility for, and you will fully indemnify TI and its representatives against, any claims, damages, costs, losses, and liabilities arising out of your use of these resources.

TI's products are provided subject to TI's Terms of Sale (www.ti.com/legal/termsofsale.html) or other applicable terms available either on ti.com or provided in conjunction with such TI products. TI's provision of these resources does not expand or otherwise alter TI's applicable warranties or warranty disclaimers for TI products.

Mailing Address: Texas Instruments, Post Office Box 655303, Dallas, Texas 75265
Copyright © 2018, Texas Instruments Incorporated